

1983 Camper

Supplement to Volkswagen
Vanagon Owner's
Manual



Storage and Cabinets 4

Water and Electricity 7

Stove and Tables 14

Refrigerator 16

Beds 19

Pop-up Roof 21

General 23

WELCOME to the growing family of VW Camper owners!

You now own a Volkswagen for day-to-day driving and a comfortable home away from home. Safe, dependable transportation, custom equipped for recreation and fun.

The VW Camper looks like a VW Station Wagon. And it IS a VW Station Wagon at heart. Your Vanagon Owner's Manual explains everything you should know about the vehicle. Be sure to read the Owner's Manual to learn how to operate your Vanagon safely.

On the following pages, you'll see what makes your Vanagon a Camper. We'll tell you all about the equipment in your Camper and how to use it. Take a few minutes to read this manual and make yourself at home—literally.

NOTE TO OWNERS

In Canada, this manual is also available in French. To obtain a copy, contact your dealer or write to:

NOTE AUX PROPRIETAIRES

Au Canada on peut se procurer un exemplaire de ce Manual en français auprès du concessionnaire ou du:

**Volkswagen Canada Inc.
Customer Assistance/Assistance à la Clientèle
1940 Eglinton Ave. East
Scarborough, Ontario M1L 2M2**

Test, illustrations and specifications in this manual are based on information available at the time of printing. It has always been Volkswagen's policy to continuously improve its products. Volkswagen, therefore, reserves the right to make changes in design and specifications, and to make additions or improvements in its product, without incurring any obligation to install them on products previously manufactured.

**WESTFALIA-WERKE, FRANZ KNÖBEL & SÖHNE KG
4840 WIEDENBRÜCK, W. GERMANY**

May not be reproduced or translated in whole or in part without the written consent of Volkswagenwerk. Specifications subject to change without notice.
All rights reserved. Printed in W.-Germany. W 42-023-960-1

www.WestfaliaT3.info - a useful website for owners and enthusiasts of VW Westfalia T25 / T3 / Vanagon Campervans

Contents

B

Battery	12, 18
Beds	19

C

Camper seat	4
Camping gear	24
Capacities-water tank	7-8
Ceiling cabinet	5
Circuit breaker	11
City water connection	7, 9
Cleaning	10, 17, 24
Clothes closet	5
Curtains	20

D

Defrosting refrigerator	18
Doors	5
Drainage-water	9, 18
Drainboard	6

E

Electric refrigeration	18
Electrical system	11-13

F

Fire extinguisher	14
Floor plan	Inside back cover
Fuses	13

G

Gas refrigeration	17
Gas stove	14
Gas tank	14

H

Heat shield	6
-------------	---

I

Insect screens	20
Interior light	13

L

Linen closet	5
Luggage rack	22

P

Pop-up roof	21-22
Propane gas tank	14

R

Rear deck mattress	19
Rear seat bench	4, 19
Refrigeration-electric	17
-gas	16
-fuse	13/16
Refrigerator	16

Refrigerator defrosting	17
Roof bed	19
Roof hinges	22

S

Sink cabinet	6
Sink cabinet cover	6
Storage chest	4
Storage locker	4
Sliding dor	23

T

Tables	15
--------	----

V

Ventilation-cooking	14
-general	23
-refrigeration	18
-sleeping	20, 21
-water tank	8

W

Water drainage	9
Water pump fuse	13
Water pump switch	7
Water supply	7
Water tank reserve	8
Water tank filling	8
Winter camping hints	23

STORAGE AND CABINETS

Storage locker

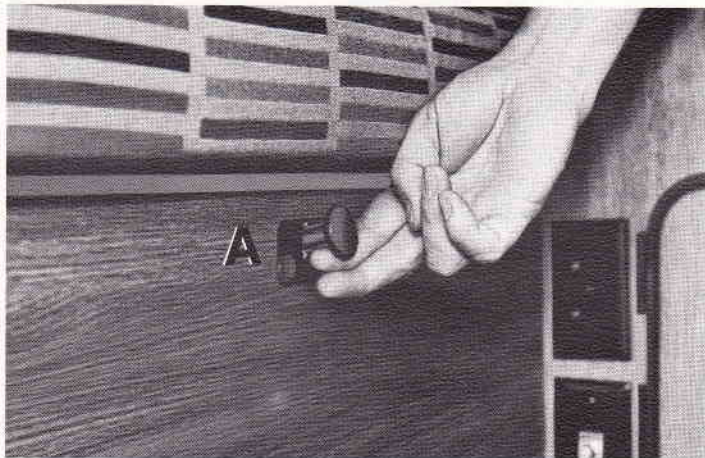

The large storage compartment is under the seat cushion of the rear bench.

To gain access to the storage space, pull release knob **A** up and lift the seat cushion. Secure the seat cushion lid with support rod **B** provided on the left-hand side.

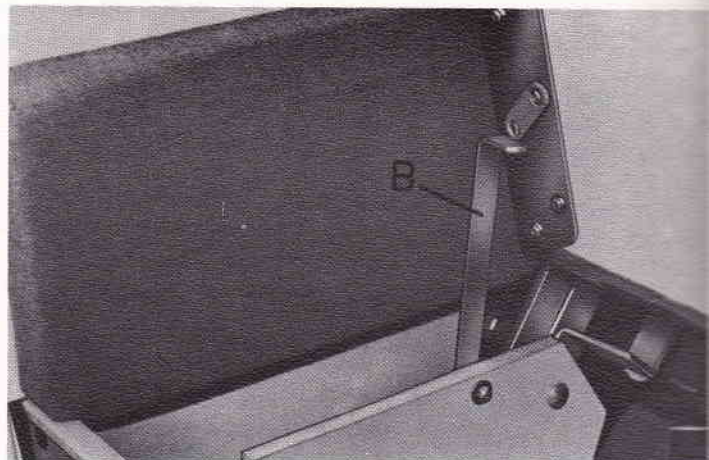

Another storage chest is located between the sink cabinet and clothes closet.

The water tank is located in the storage chest. (See page 8-10).

Clothes closet

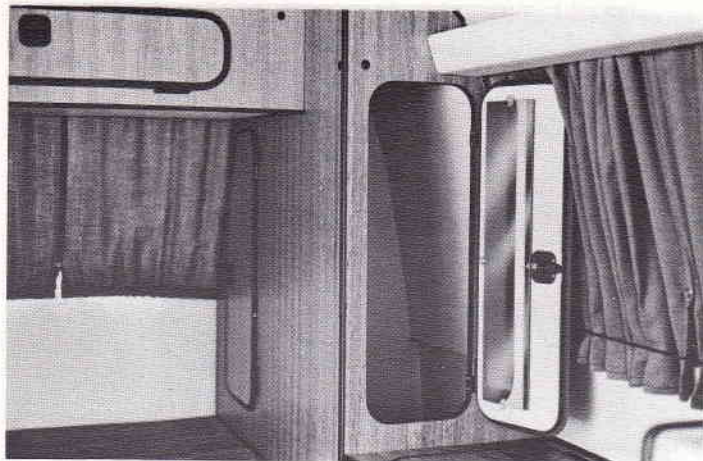

The clothes closet comes with a hanging rod and a vanity mirror.

Linen closet

A roomy linen closet is built into the left rear side wall. The three compartments are most easily accessible through the open hatchback.

Ceiling cabinet

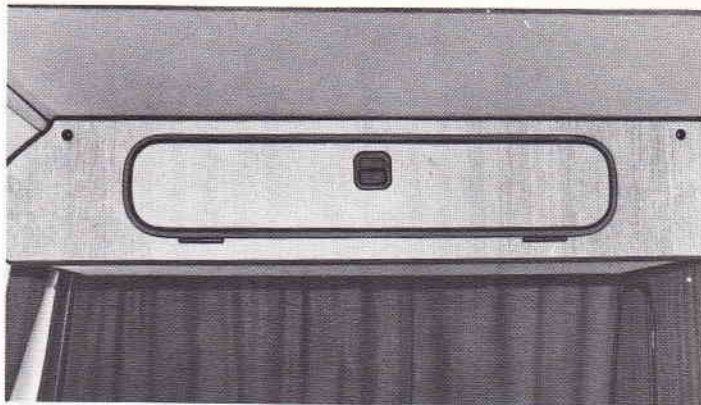

The ceiling cabinet is located in the rear of the vehicle above the rear deck mattress. Store only light items in the ceiling cabinet. The maximum weight must not exceed 20 lbs or 10 kg.

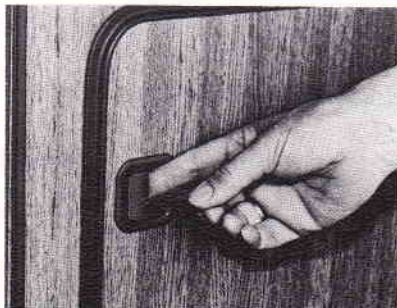

Doors

To open cabinet and storage chest doors, lid covers and utensil drawer, pull the recessed handles.

Sink cabinet

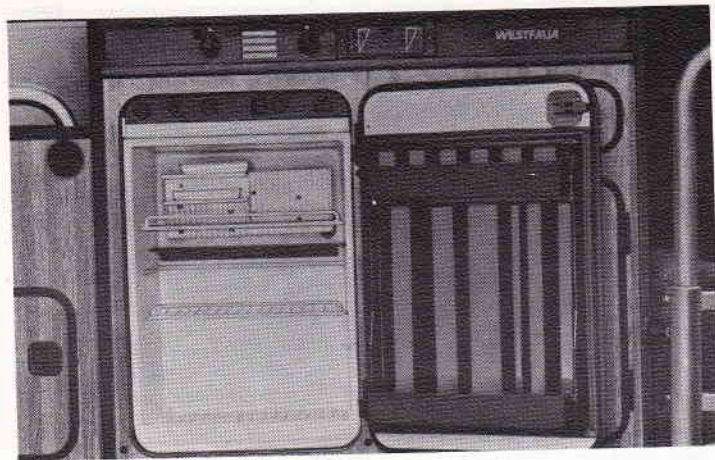

The sink cabinet is divided into two sections.

The left section is equipped with a 1.5 cu. ft. (45 liters) refrigerator (see »Refrigerator« for details).

The right section holds a utensil drawer and a pantry for storage of non-perishable items.

Food and drink items should not be jammed together. Leave enough room for the necessary air circulation. Use unbreakable plastic bottles and containers. Avoid glass containers on camping trips. All containers should be sealed tightly to avoid spillage.

Sink cabinet cover

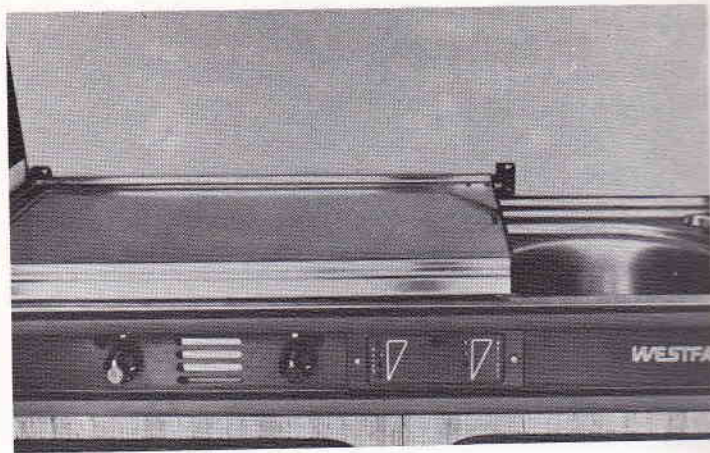

Before opening the lid cover, slide the driver's seat forward to make room.

The left underside of the lid cover has a stainless steel heat shield/drain board. The heat shield can be unsnapped to cover the gas burners. While leaving the sink open for dish washing, the heat shield provides convenient drain board space.

In the Canadian version the heat shield cannot be unsnapped and used as a drainage board.

CAUTION

Do not put the heat shield over an open flame or a hot burner. Never attempt to use the heat shield as a hot plate or grille.

WATER AND ELECTRICITY

Water supply

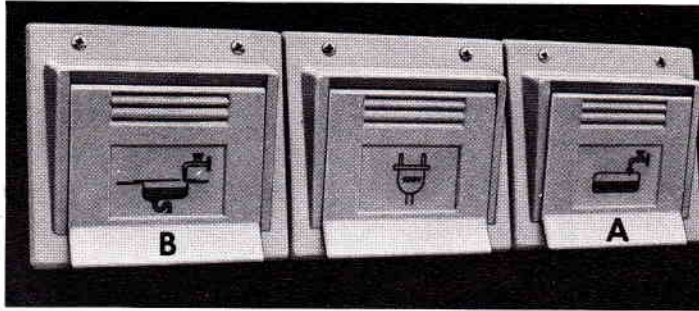

City water connection

To provide you with the convenience of an ample water supply at campsite, a hose fitting **B** has been installed in the left side panel of the vehicle.

When **city water is not available**, you can carry your own supply in the built-in water tank, located in the storage chest between sink cabinet and clothes closet. The water tank can be filled from outside through the lockable filler cap **A** installed in the left side panel of the vehicle.

Tank capacity is 13.2 US gal. or 50 liters.

Remember that any weight carried affects fuel economy. Consider filling your water tank shortly before you reach the campsite and not at home.

Water pump switch

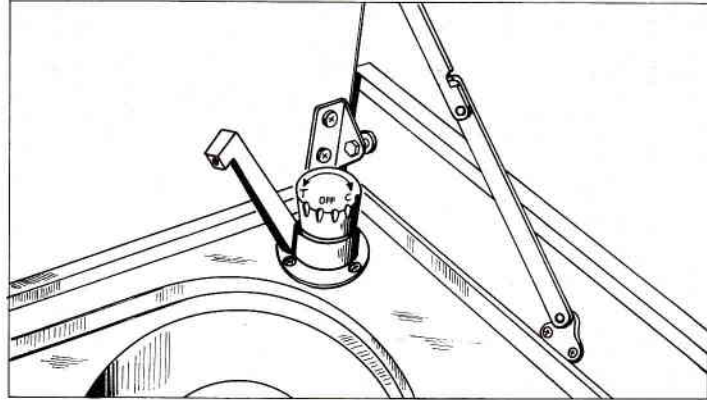

The electric water pump is immersed inside the water tank. After filling the water tank, and the green indicator light in the control panel comes on, activate the water pump by turning the switch knob on top of the faucet to the left; in direction **T** (Tank). Turn the knob several times in 10-second intervals to bleed the hose until water runs into the sink.

NOTE

When the city water hose connection has been made, turn the water pump switch knob on top of the faucet in direction »C« (City).

Water tank filling

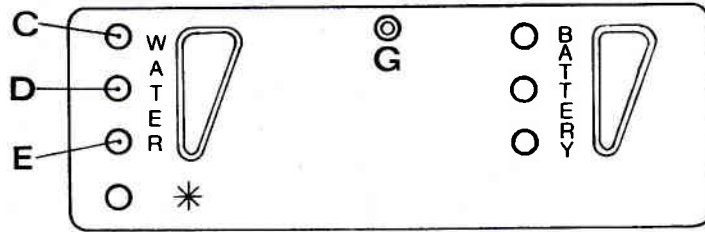

The water pump and all lights in the control panel can be turned on or off with switch **G**. The **left** light column indicates how much water is left in the tank. The **right** light column indicates the condition of the battery explained on page 12.

- C** green: 13.2–10.5 US gal. or 50–40 liters
- D** yellow: 10.5– 4.0 US gal. or 40–15 liters
- E** red: 4.0– 0.8 US gal. or 15– 3 liters

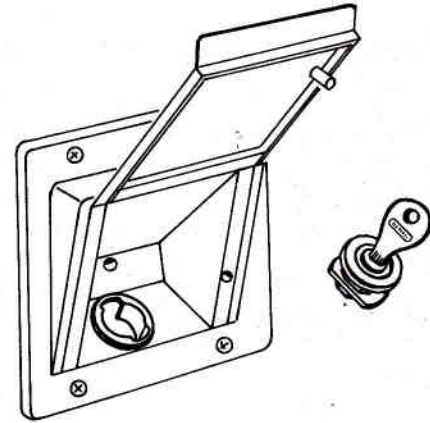

To **unlock** the filler hose stopper, turn the key clockwise one **quarter** of a turn and pull stopper out.

To **lock** the filler hose opening, insert stopper, turn key counter-clockwise one quarter of a turn and remove key.

The water tank vent pipe opening is located above the filler hose stopper.

The protective cover should not be removed, nor must the vent pipe opening be closed off.

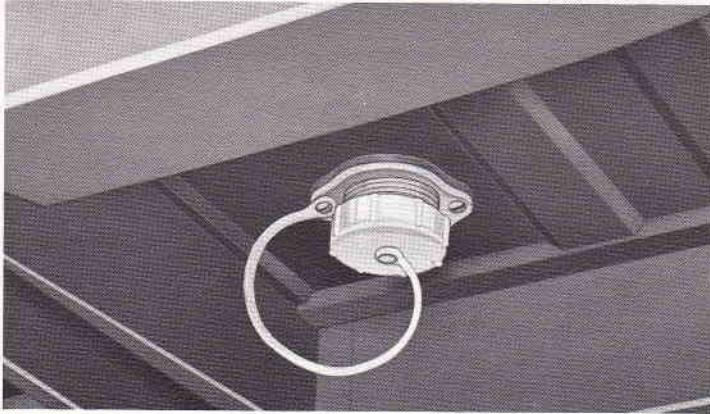

Water drainage

The sink drain pipe extends through the underbody of the vehicle to an opening aft of the left front wheel. The drain pipe opening has a screw-on plastic cap. Remember to remove the cap before using the sink, and always replace the cap securely when the sink is not in use.

Water from the sink drains onto the ground. Therefore, be mindful of where you drain the sink water.

The drain plug for the water tank is located under the vehicle in front of the left rear wheel. Always replace the screw-on cap securely after cleaning the water tank.

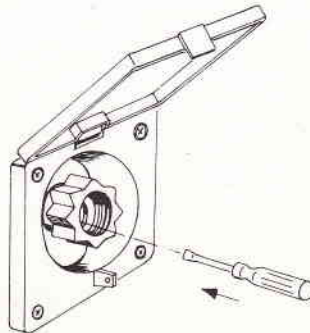
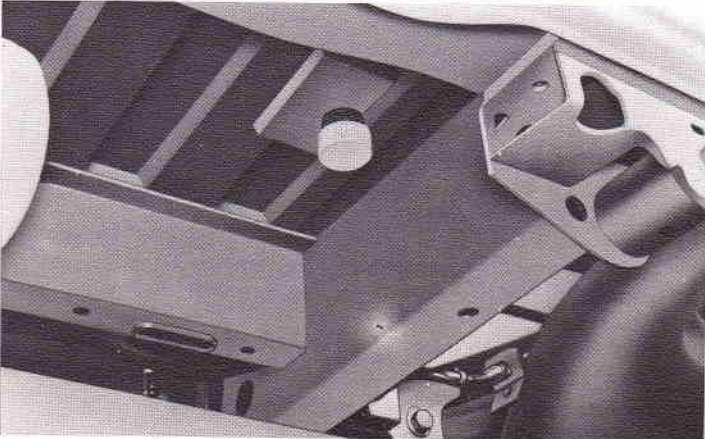

When danger of frost exists, make sure water is not left in the city water connection. Press screwdriver into valve opening until water is drained.

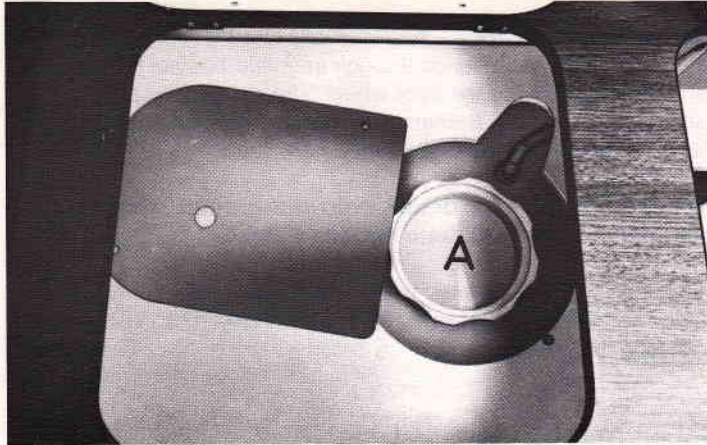

Water tank

We recommend you drain the water tank after every trip.

Tilt up storage chest lid.

Unscrew the cover shield and remove the plastic stopper **A**.

Unscrew the drain plug to empty the tank. Close the drain plug but leave the stopper open to allow the tank to air out. Should there be an odor, flush the tank with a solution of baking soda and water. Rinse the tank thoroughly with clear water and allow it to dry.

Electrical system (110-125 Volt AC)

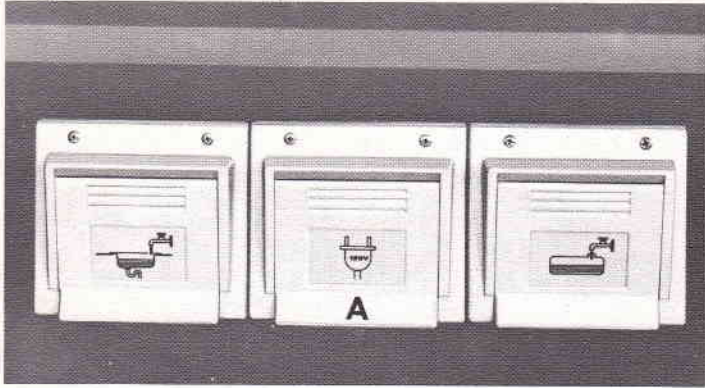

Your Camper is equipped with an electrical system that can be connected to regular house current available at many campsites.

In the left side panel of the vehicle, there is a three-prong hook-up receptacle **A**. The 15 Ampere AC electric cord for this purpose is standard equipment with your Camper.

On Canadian models, the outside electrical cord connection is permanently installed. To make the outside hook-up, pull the cord out of the receptacle. Push the cord back into the receptacle before leaving the campsite.

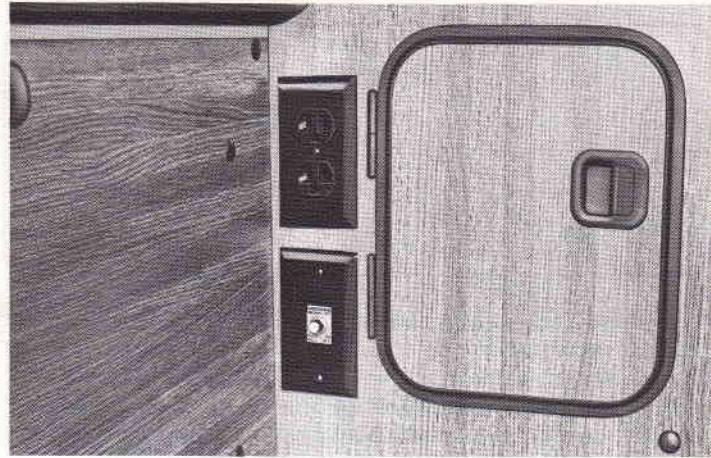

On the inside of the vehicle, in the kick panel of the storage chest, next to the rear bench, are two three-prong outlets and the circuit breaker with the master switch. These outlets can only be used when connected to outside current and for electrical appliances requiring 110-125 Volt.

In case of a short circuit or overload, the circuit breaker will interrupt the power flow. **Eliminate cause of overload first by unplugging appliances.** Then reset the circuit breaker by depressing the switch.

Two three-prong outlets for electric refrigeration are located on the upper left side wall of the pantry section in the sink cabinet.

Battery (12 Volt)

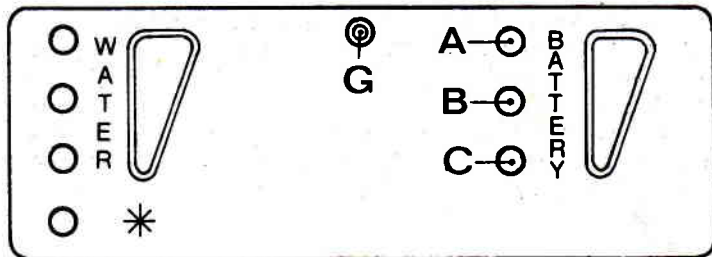

You will find detailed information in your Owner's Manual as to the location, maintenance and charging of the battery. Bear in mind that in addition to the normal vehicle electricity used for lights, ignition, radio, etc., your battery also feeds the interior light over the sink, the refrigerator, water pump, control lights in sink cabinet, and any appliances plugged into the plug on the dashboard.

The **right** light column indicates the condition of the battery when the switch in the center of the panel is switched on.

- A** green light > 12.5 Volt
- B** yellow light < 12.5 Volt
- C** red light < 12.0 Volt

Should the yellow light come on, your battery is near the point where you should preserve battery power needed to start the engine.

All lights in the control panel, as well as the electric water pump can be turned on or off with switch **G**.

Interior light (12 Volt)

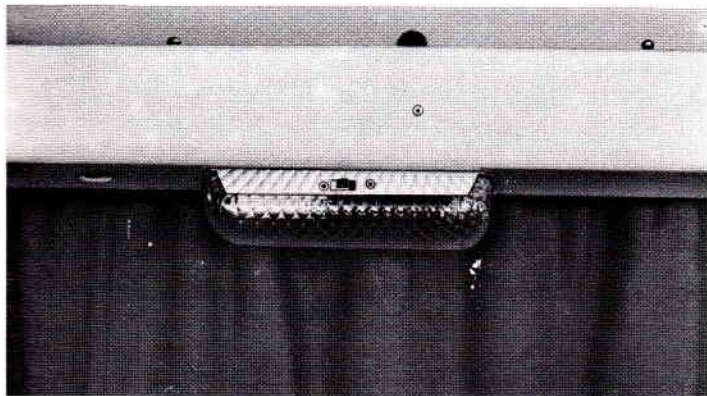

The light housing is located above the sink cabinet. To turn the light on or off, depress the switch in the center of the housing. The cornice above the light housing can be used to store small items.

Fuses (12 Volt)

A small fuse box, located on the door post behind the driver's seat just below the seatbelt retractor reel housing, holds the following two fuses:

Refrigerator 16 Amp.

Water pump and lights in sink cabinet control panel 8 Amp.

You will find detailed information in your Owner's Manual on the location of the main fuse panel in your Camper.

When a fuse is blown, it is not sufficient to merely replace it. The cause of the short circuit or overload must be found and corrected first. On no account should a fuse be patched up with tin foil or wire as this may cause serious damage elsewhere in the electrical circuit. Make it a habit to always carry a few spare fuses in your Camper.

STOVE AND TABLES

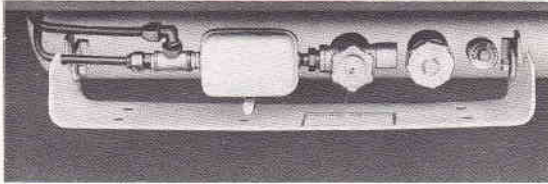

Propane gas tank

The liquid propane gas tank is located under the left side panel of the vehicle. The equipment includes two pipe lines; one for cooking and one for refrigeration. Instructions for refilling the tank are listed on the sticker and in a separate pamphlet. The propane gas tank capacity is 3 gallons/12 liters.

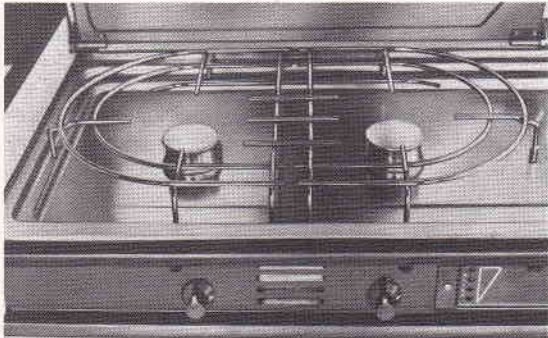

Gas stove

PRACTICE SAFETY AT ALL TIMES!

- DO NOT USE THE GAS RANGE WHILE DRIVING!
- Keep combustible materials clear of lighted burners.
- The burner orifices have been set by the factory for safe operation. DO NOT CHANGE THEIR SIZE!
- Keep a lighted match ready when turning on the burners.
- Keep windows or door open when cooking. Gas flames consume oxygen.
- Never light the burners to heat the interior of your Camper.
- Make sure the propane tank is securely fastened in place.
- Check tank and lines from time to time to be sure they are tight. When testing for leaks, use soapy water. DO NOT USE MATCHES!
- Do not put the sink cabinet cover over an open flame. Wait till the burners and the cooking rack are cold.
- After cleaning the stove, make sure to anchor the cooking rack securely in the slots provided.



IN CASE OF FIRE!

The dry chemical fire extinguisher is located behind the passenger seat.

- Release fire extinguisher from holding bracket
- Remove the tape over the white discharge button.
- Hold the fire extinguisher upright and press the button all the way down.

Aim the spray at the base of the flame. Do not test the fire extinguisher. Partial discharge may cause the contents to leak.

Dinette table for passenger compartment

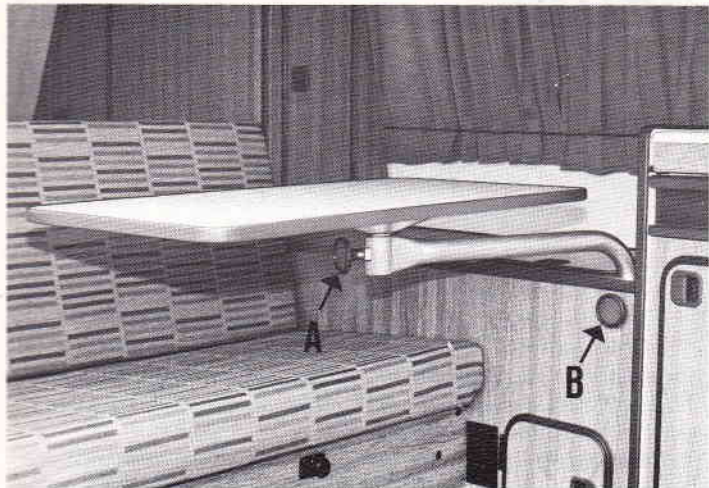

The swivel type table top can be moved out of the way to a storage position above the storage chest. For meal time comfort, the table can be adjusted with the two rotary knobs **A** and **B**.

When in use, be careful that the table top edge does not press against the gas range knobs.

Dinette table for driver cab



For meal time comfort, adjust the swivel table top with two rotary knobs, one below the table top and one at the table leg.

Please refer to the Owner's Manuals for adjustment procedures of the front bucket seats.

CAUTION

Do not climb onto the table tops to get to the upper bunk bed. The table top swivel mountings cannot support heavy weights.

REFRIGERATOR

Refrigeration

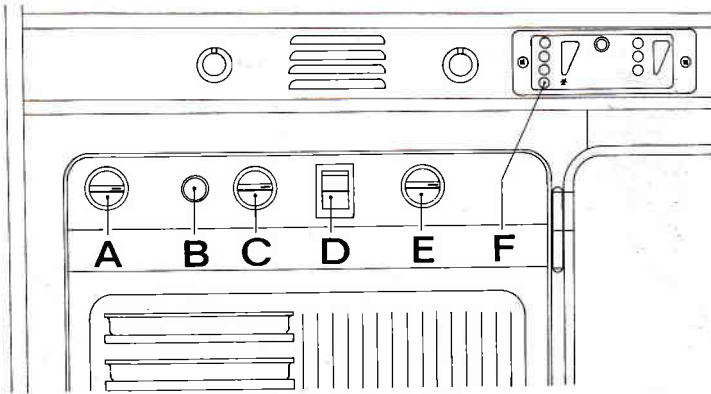

The controls for **gas/electric** refrigeration are arranged along the top edge of the refrigerator. They are accessible by opening the refrigerator door.

Start-up procedure for propane operation:

- 1) Turn the gas valve on propane tank to **ON**.
- 2) Move voltage selector switch (**D**) to **GAS** (center position).
- 3) Turn gas valve knob (**E**) to **ON**.
- 4) Turn thermostat control knob (**C**) clockwise to **MAX**.
- 5) Pull knob (**A**) and pump in and out at least 15 to 20 times.
- 6) Press and hold safety valve switch (**B**), at the same time push knob (**A**) in completely until an audible click is heard.

- 7) Continue to hold safety valve button (**B**) until the flame indicator light (**F**) in the sink cabinet control panel comes on and remains on. This should require about 15-30 seconds.
- 8) If the flame indicator light (**F**) does not come on or, if it flickers on but goes out again, the pilot light has failed to ignite to a steady burn. This might happen if the refrigerator has not been used for some time, or if the outside temperature is low. **Repeat steps 5-7.**
- 9) After a few minutes, check the flame indicator light (**F**) again, to assure yourself that the pilot light is still burning. The pilot light flame can also be observed through the sight glass in the lower left hand corner of the rear wall inside the refrigerator.
- 10) Should the pilot light snuff out unexpectedly, the flame indicator light (**F**) will also go out, and the thermocouple safety valve will automatically shut off the gas flow.
- 11) Temperature inside the refrigerator can be regulated with thermostat control knob (**C**). The center position will usually maintain sufficient cooling. In hot weather, or when more cooling is required, turn the knob toward **MAX**.

To discontinue gas operation:

- 1) Turn knob (**A**) to **OFF**.
 - 2) Turn gas valve knob (**E**) to **OFF**.
 - 3) Turn thermostat control knob (**C**) to **GAS MIN**.
- To assure yourself troublefree gas refrigeration at altitudes above 6500 feet or 2000 meters, it is necessary to install a smaller gas burner jet. Therefore, if you use your camper predominately at high altitudes, the no. 24 jet installed in the burner tube should be replaced by a no. 22 jet. Contact the Dometic Refrigerator Service center in your area for this service.

NOTES

- When the liquid propane tank is refilled, air will remain in the gas line. Before using gas refrigeration, we recommend bleeding the system by lighting the burners of the gas stove. Let burners burn for about one minute. This will help air escape more rapidly.

Procedure for electric operation:

- 1) Move voltage selector switch **(D)** to **AC 120 V**
- 2) Make sure gas valve knob **(E)** is in **OFF** position.
- 3) Turn thermostat control knob **(C)** clockwise to **MAX**. When the refrigerator interior is sufficiently cold, turn knob **(C)** from **MAX** to an intermediate setting.

The 12 Volt power supply from the vehicle battery can be used only when the engine is running and the voltage selector switch **(D)** is set on **DC 12 V**.

The 12 V circuit is not thermostatically controlled.

To discontinue electric operation:

- 1) Move voltage selector switch **(D)** to **GAS** (center position).
- 2) Turn thermostat control knob **(C)** to **GAS MIN**.

Defrosting the refrigerator

Keep an eye on the ice formation on the evaporator core. Too much ice build-up reduces cooling efficiency. We recommend frequent defrosting. Never let the ice thicken more than $\frac{1}{8}$ " (3-4 mm).

Make sure that gas valve knob **(E)** is in **OFF** position, and that thermostat control knob **(C)** is in the **GAS MIN** position.

Empty the refrigerator, leave the door open and let the ice melt into the catch basin below. Pull the basin out to empty the water and dry off before reinstalling.

Cleaning the refrigerator

Clean the refrigerator interior with a solution of lukewarm water and baking soda.

To keep the door seal air tight, clean the seal around the door with clear water only. Chemical additives, oil and grease must not come into contact with the seal.

Ventilation



Keep all vent openings clean and unobstructed to assure efficient cooling. Vent openings are located below the refrigerator door, behind the heat shield of the gas range, in the left sidewall of the sink cabinet, and in the left outside panel of the vehicle.

Inspect the propane tank and lines periodically for tightness and leaks. **Use soapy water to test for leaks – NOT MATCHES!**

Start refrigeration several hours before storing food. Precool or freeze food items at home before loading your Camper refrigerator.

Leave spaces between food and drink items for the necessary air circulation. Use unbreakable plastic containers and bottles, and seal them tightly to prevent spilling.

Condensation

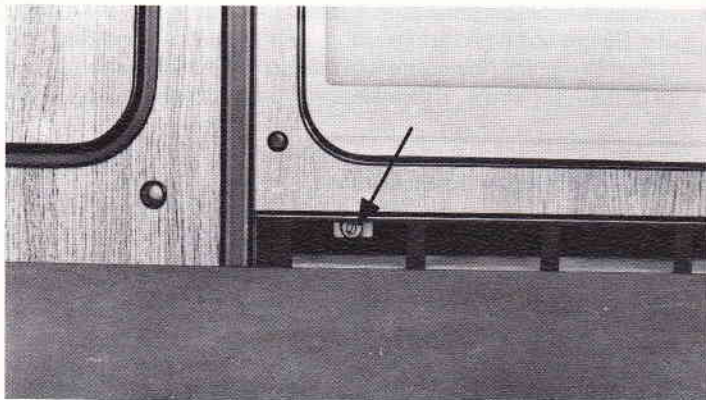

The FLU VENT must be kept uncovered at all times.

Only when you wash the Camper, or while taking the vehicle through an Automatic Car-Wash, should the FLU VENT be covered. To drain accumulated water due to normal condensation, open the screw on the condensation drain pipe (arrow).

When the refrigerator is operating, be sure to park on level ground to maintain efficient cooling. If the vehicle remains stationary for any length of time on gradients exceeding $\pm 8^\circ$, the cooling output will be considerably reduced. Should level ground parking be unavailable, it is best to discontinue operation to prevent overheating of the core which can lead to permanent damage of the refrigerator.

BEDS

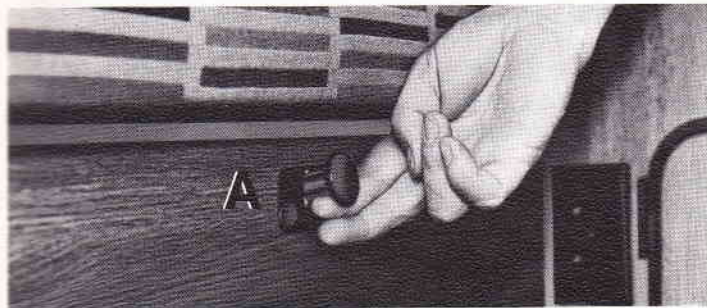
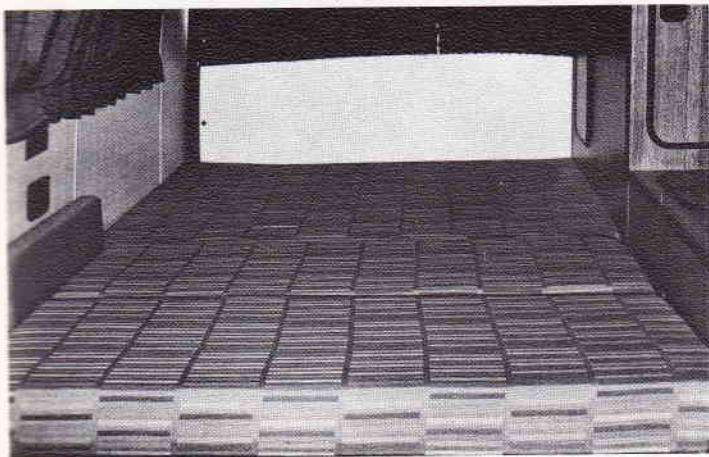

Lower bed

The rear seat bench unfolds to become a full-size double bed. To set up the bed

- move dinette table to storage position
- push safety belts between seat cushion and backrest
- pull release knob **A** up while lifting the seat cushion slightly
- pull seat cushion toward you until backrest folds flat onto support between seat and rear mattress.

When returning the rear bench to an upright position, lift the seat cushion up till the side hinges snap the backrest into position. Then swing the entire unit toward you and make sure the safety catch on the storage locker is securely engaged.

CAUTIONS

- **Do not place heavy or sharp edged objects on the rear deck mattress to avoid damaging the upholstery. Such objects may also become dislodged while driving and cause injury.**
- **Do not use the double bed to carry passengers.**
- **Do not allow children to sit or kneel on the rear deck while the vehicle is in motion.**
- **When the car is in motion, make sure that the seat bench is securely locked in an upright position and that passengers wear safety belts.**

Roof bed

A double bed mattress is built into the pop-up roof. The bed is folded away when the roof is down. With the roof up, pull the mattress toward you about 4' (10 cm) and then fold open.

Curtains



The curtains cover all windows in the Camper, even the windshield to give you complete privacy. The passenger compartment curtains are mounted on built-in curtain rods. When closed, the curtain panels can be snap-fastened to each other, and an elastic band holds the bottom hem flush against the vehicle's side walls. The curtain cornice above the sink, cabinet can be used to store small items.

The curtain for the windshield and front door windows can be installed with the snap fasteners provided.

Safe driving requires that you have an unobstructed view of the road at all times. Remember to reposition the curtains so that you have a clear view all around you before driving off.

Insect screens

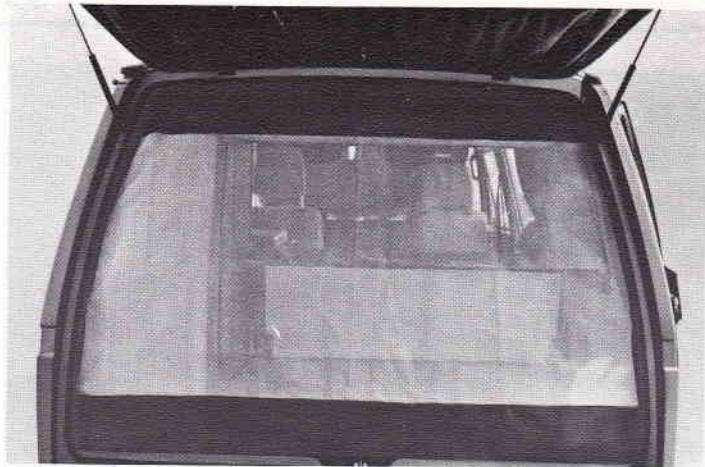

To provide maximum flow-through ventilation for comfortable sleeping at night, insect screens are installed on the sliding side windows. The screens can be removed for cleaning.

The hatchback screen can best be installed with the hatchback open. Simply press the snap-fasteners into the locations provided. The hatchback can be closed with the screen installed.

Always keep the hatchback closed while driving to prevent exhaust gas from being drawn into the vehicle.

POP-UP ROOF

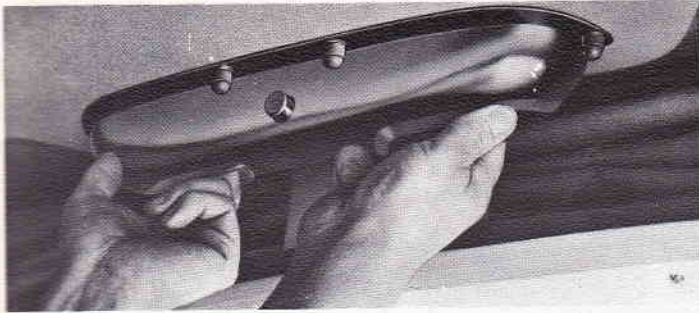

The roof of the Camper is equipped with a fiberglass-reinforced polyester top. The larger rear portion is the **actual pop-up roof**.

To raise the pop-up roof –

- Pull down the lock cover with both hands to release and disengage the lock latch by firmly pressing the latch toward you.
- Push the roof up as high as possible.
- Grasp the crossbar and push up all the way until the strut supports at the front of the pop-top are securely locked into position.

Caution

To prevent damage to the top and sides of the pop-up roof, the Camper should never be driven with the top in the elevated position.

Before closing the pop-up roof, open a door or window to prevent the canvas sides from billowing out due to air pressure build-up.



To close the top –

- Flip the front portion of roof bed mattress toward rear.
- Pull the crossbar back and slowly lower the roof.
- As you lower the top, gather in the canvas sides of the top **A & B**. Have someone outside the vehicle help make sure the fabric does not stick out from the sides of the roof.
- Assuring yourself that no part of the canvas is caught in hinges or latch, grasp lock cover with both hands and pull down until lock latch snaps shut securely.

NOTES

- To prevent mildew from forming on the flocking and the canvas of the pop-up top, the roof should never be closed when wet.
- When raising the pop-up top, keep the front flap in the canvas open to assure fresh-air circulation.
- Air circulation must not be hindered by storing bedding, etc., on the surface of the rear portion of the roof bed mattress.

Luggage rack



The front section of the roof contains the luggage rack, which is equipped with buffer rods and tie-down hooks to secure baggage. The rack is accessible through the front flap of the pop-up roof. All baggage carried on the roof rack must be firmly tied down. Commercially available spider straps will keep the cargo from shifting.

Do not exceed the maximum permissible roof rack weight of 110 lbs or 50 kg.

Roof hinges



The hinge pins on the strut supports of the pop-up roof should be lightly oiled from time to time, to assure easy opening and closing of the top.

Before closing the pop-up roof, open a door or window to prevent the canvas sides from billowing out due to air pressure build-up.

GENERAL

Identification plate

The identification plate in the lower left-hand corner on the kick panel of the rear seat bench contains the vehicle type and Camper equipment serial number. Please give these numbers when ordering spare parts for the Camper equipment.

Repairs

Any repairs on the gas range or the refrigerator should only be performed at service establishments authorized by the manufacturer. They are listed in a pamphlet you will find in the sink cabinet.

Ventilation

When using the Camper as living quarters, fresh air circulation is important for your well-being and safety. Keep both front vent windows open or lower the door windows a few inches to let in fresh air. Used, stale air will escape through the screened sliding window above the sink cabinet. Keep the windows open, especially while cooking.

Sliding Door

When closing the sliding door inside, try not to slam it shut. With your left hand pull the door handle forward and slide door up to striker plate. With your right hand take hold of the grab handle on the door panel. Then close the door with a quick and firm pull forward. Move the small sliding knob down to latch the door securely.

Winter camping hints

When parking on snow covered or icy surfaces, chock all wheels to prevent the Camper from sliding, especially when it thaws. Do not set the parking brake.

Condensation and fogging inside the vehicle can be effectively controlled by circulation of a mixture of fresh and heated air. If you do not use your Camper at outside temperatures below 32° F or 0° C, empty the water tank and drain the water lines to prevent damage caused by freezing water.

Pop-up-roof

If the roof bed is not in use very often, open the pop-up roof periodically to let fresh air circulate. You may also remove the mattress for airing to prevent mildew.

Cleaning

Roof top – The luggage rack and the hood of the pop-up roof can be cleaned with clear water or with a commercial polish suitable for lacquered surfaces.

Curtains – The curtains can be dry cleaned or hand washed in warm water using a mild detergent

Upholstery – The 100% polyester fabric in your Camper is protected by Scotchguard®. Vacuum or use dry shampoo.

Carpeting – Vacuum or use dry shampoo.

Cabinets – Cabinets, paneling and other plastic interior trim can be cleaned by wiping with a damp cloth. For heavy dirt or stains use VW All-purpose Cleaner available at your VW dealer.

Avoid harsh cleaning agents and always follow instructions on the container.

When cleaning cabinets, floors and upholstery, never use gasoline, kerosene, naphta, nail polish remover or any other volative solvents. They may be toxic, flammable or hazardous in other ways. Keep all cleaning agents out of the reach of children.

Camping gear

Camping out can be a lot of fun but it takes some preparation. Although we have a few suggestions for your next trip, this list is not complete and can be tailored to your individual needs.

First-aid kit and first-aid manual.

Flashlight or lantern.

Three-prong power cord extension.

Water hose with connection for city water hook-up.

Hose to attach to sink drain for better disposal of drain water.

Waterproof matches.

Folding shovel (entrenching tool).

Plastic bags for garbage disposal and odds and ends.

Water-purification kit.

A small saw and axe.

Lightweight nylon rope.

Suntan lotion and insect repellent.

Sewing kit.

Rain gear, just in case.

Canopy cover for picknick table on campsite.

Folding campchairs.

Games and puzzles for the children.

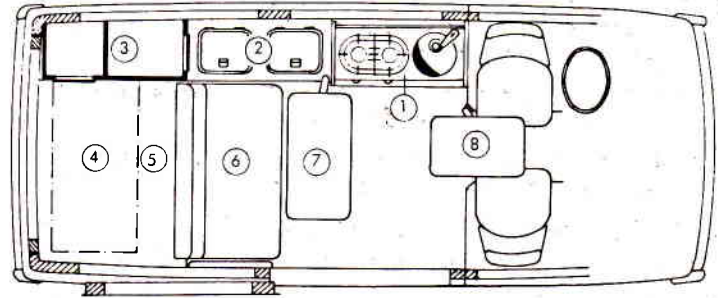

1. Sink cabinet including:
 - gas stove
 - sink
 - refrigerator – gas or electric
 - storage cabinet
 - sink cabinet cover with heat shield/drainboard
2. Storage chest with water tank and storage space
3. Clothes closet with rod and vanity mirror
4. Ceiling cabinet
5. Rear deck mattress*
6. Rear bench seat* with storage locker
7. Dinette table rear
8. Dinette table front

* 5 and 6 combine to make the double bed