

# Volkswagen Transporter Volkswagen Caravelle Instruction Manual



[www.WestfaliaT3.info](http://www.WestfaliaT3.info) - a useful website for owners and enthusiasts of VW Westfalia T25 / T3 / Vanagon Campervans

*Congratulations on your new  
Volkswagen Transporter/Volkswagen Caravelle  
You have made a wise decision*

*The Transporter/Caravelle is a versatile, million-fold proven vehicle.*

*But, you have not only opted for an outstanding vehicle with modern, low maintenance technical components, you have also chosen quality.*

*A quality ensured by the most up-to-date production technology, careful selection of materials and conscientious work by all involved.*

*And with the Transporter/Caravelle you have also chosen one of the largest and most efficient Service Organizations.*

*In Europe alone there are around 7,000 V.A.G dealerships.*

*We wish you pleasant motoring:*

*Your*

**VOLKSWAGENWERKAKTIENGESELLSCHAFT**

[www.WestfaliaT3.info](http://www.WestfaliaT3.info) - a useful website for owners and enthusiasts of VW Westfalia T25 / T3 / Vanagon Campervans

# **Volkswagen Transporter Volkswagen Caravelle Instruction Manual**

**Caravelle  
Combi  
Van  
Pick-up  
Double Cab**

With petrol engines (including catalytic converter), Diesel engines,  
Manual and Automatic gearboxes and Four wheel drive (syncro)

[www.WestfaliaCB.info](http://www.WestfaliaCB.info) © useful website for owners and enthusiasts of VW Westfalia T25 / T3 / Vanagon Campervans

This Instruction Manual is valid for all Transporter/Caravelle models available ex-factory.

Certain vehicle models such as, for example Multivan, Ambulance, Special bodies and additional items (e.g. radio sets, air conditioner) are not described in this manual but are dealt with in special separate manuals.

This manual contains many important instructions on using your vehicle. You should therefore read it carefully because the correct treatment of the vehicles serves – in addition to regular care and maintenance – to maintain the value of the vehicle and is in many cases also one of the stipulations for the upholding of warranty claims.

Special attention is drawn to the chapter Driving tips: These tell you how you can drive **safely, economically and environment-conscious**.

In addition to this Instruction Manual and any supplements which may be necessary, the following also belong to your vehicle:

- the Service Schedule
- a list of addresses of V.A.G. Dealers

In the Service Schedule you will find

- the main identification data for your vehicle
- the Inspection and Oil change intervals
- the operations which are carried out at the Inspection
- important details about Warranty.

In the list of addresses (V.A.G. Service) you will find the addresses and telephone numbers of V.A.G. Dealers in Europe and overseas and also important details concerning the V.A.G. Emergency Service.

If you have any questions in respect of the publications, please consult your V.A.G. Dealer.

Please note that certain items of equipment in this Instruction Manual marked with a \* are only standard on certain models or are only available as options on certain models. Such equipment is not always available in all export markets, etc.

## Accessories, renewal of parts and technical modifications

Accessories, parts to be fitted in and on the vehicle and unsuitable replacement parts which have not been approved by us can cause damage to the vehicle and be detrimental to driving safety. For safety reasons therefore you should use only V.A.G. accessories and Genuine Volkswagen parts.

These accessories and these parts have been designed for your vehicle and approved by us, particularly with regard to safety aspects. This means that they have our backing in respect of the legal liability conditions.

V.A.G. accessories, Genuine Volkswagen parts and the associated qualified advice can be obtained from all V.A.G. Dealers for Volkswagen Commercial vehicles. They will also carry out the installation correctly and are fully informed about the permissible technical modifications. Please appreciate that we can accept no liability for damage caused by parts not approved by us and by technical modifications – particularly with regard to installations, attachments and conversions – which are not permissible.

When modifying your vehicle, please pay particular attention to the "Regulations pertaining to bodywork" published by Volkswagen AG.

<b>INSTRUMENT PANEL</b> . . . . . 4	Warning lamps . . . . . 6	
<b>OPERATION</b> . . . . . 7	Handbrake, gear and selector levers . . . . . 23, 24, 28	Instruments . . . . . 37
Keys, doors, flaps . . . . . 7, 9, 10	Differential locks . . . . . 25	Switches . . . . . 39
Windows, mirrors . . . . . 11, 12	Steering lock/ignition switch, Starting engine . . . . . 30	Turn signals, windscreen wipers . . . . . 41, 43
Seat belts, head restraints . . . . . 13, 15	Warning lamps . . . . . 34	Cruise control system . . . . . 42
Seats . . . . . 16		Heating, ventilation, auxiliary heater . . . . . 44, 47
Stowing luggage . . . . . 22		Sliding roof, sun roof . . . . . 52
<b>DRIVING TIPS</b> . . . . . 56	Driving safely, economically and environment-conscious . . . . . 58	Trailer towing . . . . . 60
Running-in and afterwards . . . . . 56		Driving a four-wheel drive vehicle . . . . . 63
<b>OPERATING INSTRUCTIONS</b> . . . . . 68	Power assisted steering . . . . . 76	Battery . . . . . 84
Fuel, filling tank . . . . . 68, 70	Cooling system . . . . . 77	Wheels . . . . . 86
Engine oil, gear oil . . . . . 74, 75	Windscreen washer . . . . . 80	Emission control system . . . . . 90
	Brake system, pedals . . . . . 81, 83	Difficult operating conditions . . . . . 91
<b>CARE AND MAINTENANCE</b> . . . . . 93	Care of car . . . . . 93	Lifting vehicle . . . . . 98
	Maintenance, Inspection intervals . . . . . 97	
<b>DO-IT-YOURSELF</b> . . . . . 99	Spare wheel, changing wheels . . . . . 100, 101	Windscreen wiper blades . . . . . 109
First aid kit, warning triangle . . . . . 99	Fuses, bulbs . . . . . 102, 104	Emergency starting, towing, tow starting . . . . . 111, 112
Vehicle tools . . . . . 99	Headlights . . . . . 105	
<b>TECHNICAL DESCRIPTION</b> . . . . . 114	Vehicle description . . . . . 110	
	Functional description . . . . . 117	
<b>TECHNICAL DATA</b> . . . . . 119	Fuel consumption, performance . . . . . 120	Weights, trailer weights . . . . . 127, 130
Engine data . . . . . 119	Spark plugs, vee belts . . . . . 125	Dimensions, capacities . . . . . 131, 134
	Wheels, tyre pressures . . . . . 126	Identification data . . . . . 135

**There is a detailed alphabetical index at the end of this manual**

# INSTRUMENT PANEL

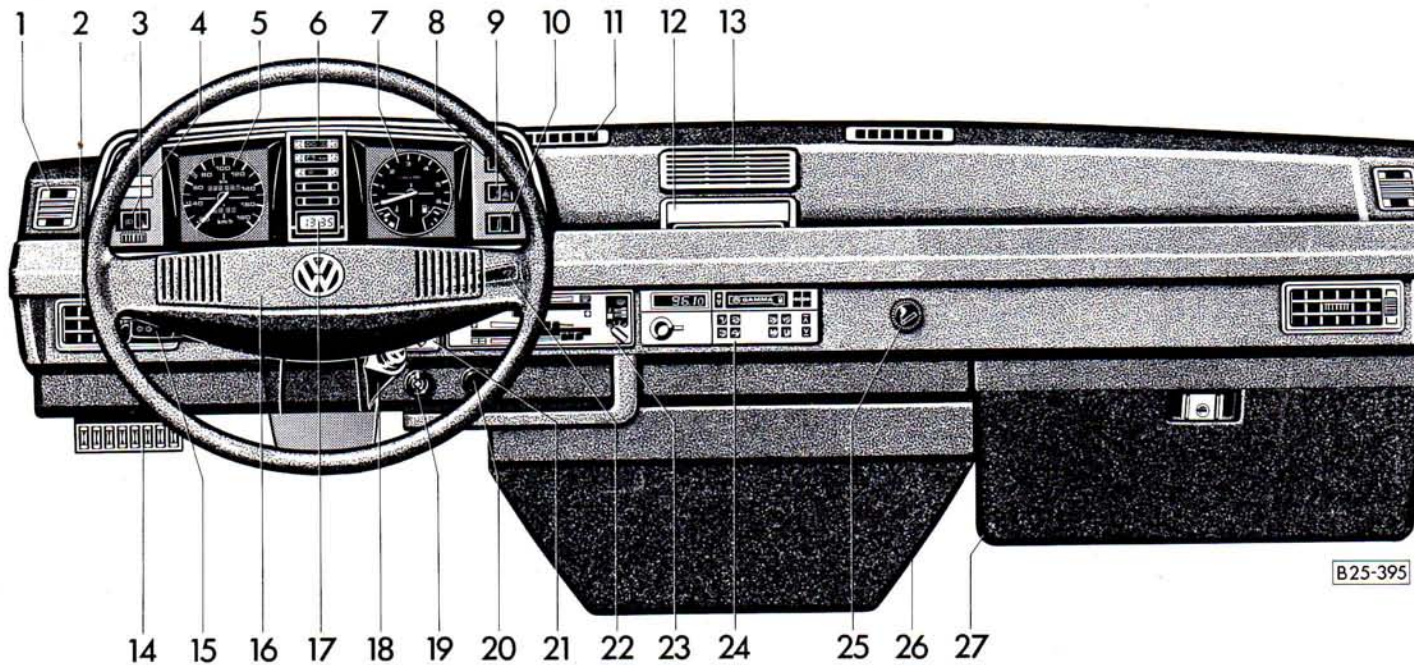

	Page		Page
1 – Air vents . . . . .	44	10 – Fog light/rear fog light switch . . . . .	40
2 – Air vents . . . . .	44	11 – Air vents . . . . .	44
3 – Light switch and instrument lighting regulator . . . . .	39	12 – Ashtray . . . . .	54
4 – Brake warning light . . . . .	36	13 – Loudspeaker opening	
5 – Speedometer . . . . .	37	14 – Fuse box . . . . .	112
6 – Warning lamps . . . . .	34	15 – Turn signal and dip switch . . . . .	41
7 – Fuel gauge and coolant temperature gauge . . . . .	38	16 – Horn control	
Clock or rev counter . . . . .	37	17 – Digital clock . . . . .	37
8 – Heated rear window switch . . . . .	39	18 – Steering lock/starter switch . . . . .	30
9 – Emergency light switch . . . . .	39	19 – Auxiliary heater switch . . . . .	47
		20 – Cold starting aid (diesel engine) . . . . .	32
		21 – Blower switch for passenger compartment heat exchanger . . . . .	46
		22 – Windscreen wiper and washer lever . . . . .	43
		23 – Blower switch and levers for ventilation and heating . . . . .	44
		24 – Radio <sup>1)</sup> or cover plate	
		25 – Socket/cigarette lighter . . . . .	54
		26 – Air vents . . . . .	44
		27 – Shelf . . . . .	55

Knobs and warning lamps for the differential locks on Transporter/Caravelle syncro – see page 26.

















**Note**

Some of the items of equipment listed are only fitted on certain models or are optional extras.

<sup>1)</sup> For vehicles with a factory fitted radio, an operating instruction leaflet is also enclosed. See remarks on page 110 of "Do-it-yourself" section when service installing a radio.

# INSTRUMENT PANEL

## WARNING LAMPS

Symbol		Page
	Turn signals	35
	Generator 	34
	Glow plugs-Diesel	35
	Engine oil pressure 	34
	Headlight high beams	35
	Coolant temperature/coolant level 	35
	Brake system 	36
	Anti-locking brake system (ABS)	36
	Emergency light system	39
	Rear window heating	39
	Fog lights/rear fog light	40
	Differential locks (syncro)	26

### Notes

■ If one of the lamps marked with  comes on when driving, stop at once and switch engine off. Details can be found on the pages given.

■ Some of the lamps shown here are only on certain models or are optional extras. On the other hand there are lamps which are not listed here because they are installed on so few vehicles.



## KEYS

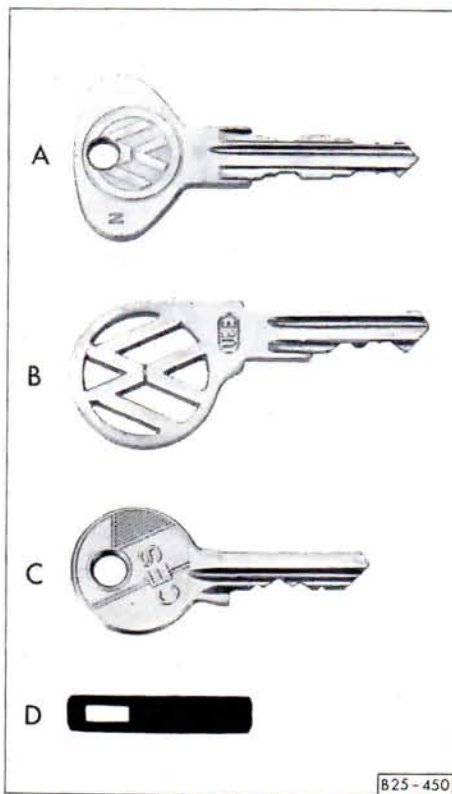

Up to six keys are supplied with the vehicle:

- two keys A
- two keys B\*
- two keys C\*

**Key A**

This key fits all locks except:

- lockable glove box
- sliding door and rear flap with safety locks

**Key B**

This key fits the lockable glove box\*

**Key C**

This key fits the safety locks in sliding door and rear flap. It can only be withdrawn when the sliding door or rear flap is locked.

**Tag D**

On this tag is the number for key A. The tag should be kept safely and separately (in your wallet for example) so that no unauthorized person can order a key. The numbers of keys B and C are stamped on the key itself.

With the aid of the number, a replacement key can be ordered from a V.A.G Workshop.

**Caution**

**When leaving the vehicle unattended – even only briefly – always take the key with you.**

**Note**

On four wheel drive vehicles there is an extra key for the lockable tank cap.

## OPERATION

### CENTRAL LOCKING SYSTEM\*

With this system all the doors, and – depending on the position of the tailgate lock – also the tailgate can be locked and unlocked.

The system is operated from the **driver's door**, and front passenger door – from outside with the key, from inside with the locking knob.

#### Note

The central locking system can only function correctly when the driver's and front passenger doors are properly closed.

When locking, the locking knobs on all doors must move down. If the knob on one door does not move at any time, open the door concerned and close it properly.

#### Caution

**When the locking knobs in the driver's and front passenger doors are pressed down all the doors are locked. Children should therefore not be left on their own in the car because when the doors are locked it would be difficult to help in an emergency.**

**Sliding door and tailgate** can be locked or unlocked separately with the key.

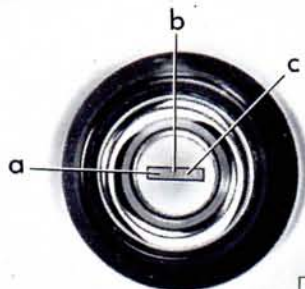

#### Note

If the central locking system should develop a fault, all the locks can be operated normally, see next page.

The sliding door can be secured and released separately with the safety ca

To unlock the tailgate insert key and turn it to right (c). Hold in this position and press button in.

If the key is withdrawn in the horizontal position (a), locking of the tailgate will be controlled by the central locking system when it is closed again.

When the key is withdrawn in the vertical position (b) and tailgate closed, it will be locked all the time. The tailgate can then only be unlocked with the key.

## DOORS

### Cab doors

**From outside** both cab doors can be locked and unlocked with the key. When unlocking the locking knobs go up, when locking they go down.

The front passenger's door can be locked from outside without using the key: Just press locking knob down and close door.

The driver's door cannot be locked when open by pressing the locking knob and closing door. This prevents you from leaving the key in the car and forgetting it.

**From inside** the door can be locked by pressing down the locking knobs. As long as the knobs are pressed down the doors cannot be opened from inside or outside.

We advise you **not** to press the knobs down when vehicle is in motion so that the door can be opened from outside in an emergency.

### Sliding door

**From outside** the sliding door can be locked and unlocked with the key. When fully open the door is held by a hook.

**To close sliding door from outside.** – Press the door handle down to release the hook and slide the door firmly forwards.

The sliding door can also be locked from outside without using the key: Press locking catch in and close door.

**From inside** the sliding door is locked by pushing down the locking catch near the door opening lever.

As long as the catch is in the lower position the door cannot be opened from inside or outside.

When the vehicle is in motion, the door must always be properly closed but when carrying passengers the locking catch should be left in the upper position so that the door can be opened from outside in an emergency.

### Child-proof catch on sliding door\*

When the child-proof catch is engaged – lever on door lock turned upwards – the inner lock release lever is inoperative. The door can only be opened from outside with the locking catch in the up position.

### TAILGATE

---

To **open** the tailgate when key hole is horizontal, press the lock cylinder and lift tailgate.

#### **Note**

The lock cylinder can also be pressed in with the key.

To close tailgate pull it down and slam it to gently.

**After closing the tailgate always pull up on it briefly to make sure that it is properly closed – otherwise the tailgate could open suddenly when vehicle is moving even though the key has been turned in lock.**

**Do not drive with the tailgate open as exhaust gases are then able to enter the vehicle interior.**

#### **Opening from inside\***

On vehicles with a full-width partition behind the cab and seats in rear compartment, the tailgate can be opened from inside in an emergency. To do this the cap must be taken off the lock in tailgate. Then press release lever to the right and open tailgate.

### ENGINE COMPARTMENT COVER

---

The cover is in the luggage compartment. To remove cover turn the two catches to the left.

On the Pick-up, the flap is in the rear panel.

## WINDOWS

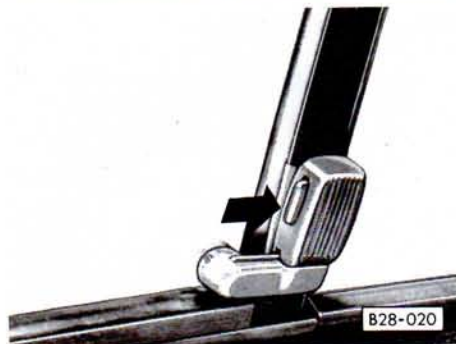
**Vent wings\***

**To open** – Press button in fastener and swing fastener forwards.

**To close** – Press window against seal at front and turn fastener to the rear until button engages.

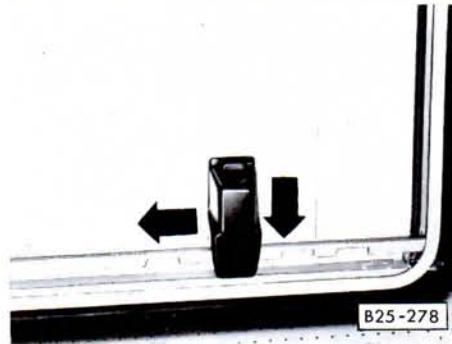
**Sliding windows\***

To open, press catch down and slide window along.

**Door windows**

These windows are opened and closed with the crank in the door trim.

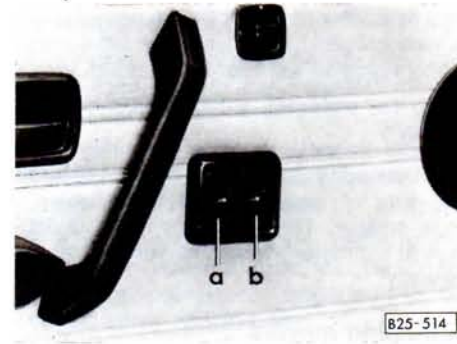
**Electrical control\***

When the ignition is on the windows can be opened and closed electrically.

The switch is in the door trim.

The window in the passengers door can be controlled from the driver's side.

**Caution**

**Careless and uncontrolled closing of the windows can cause injuries. Take care therefore when closing the windows. When leaving the vehicle always take the keys with you.**

## MIRRORS

The rear view mirror should always be adjusted properly before moving off so that good vision to the rear is obtained.

**Note for vehicles with convex outside mirror\***

Convex (curved outwards) mirrors enlarge the field of view but they make objects look smaller. These mirrors make it difficult to estimate how far the vehicle behind is away.

### Adjusting mirrors

**Normal exterior mirrors** are adjusted by moving the mirror housing.

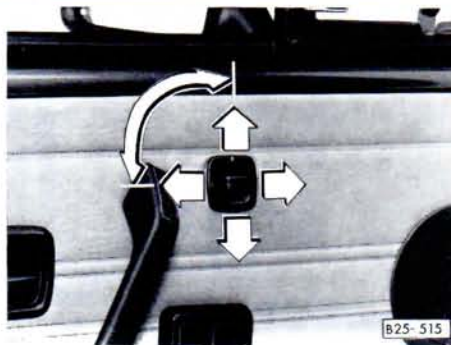

### Electrically adjustable mirrors\*

are set by moving the lever in the driver's door trim.

Turning the knob from L to R switches control from left to right mirror.

If the electrical control of the mirror fails at any time the mirrors can be adjusted by hand by pressing on the edge of the mirror surface.

### Mirror heating

The electrically operated exterior mirrors are heated when the heated rear window is switched on.

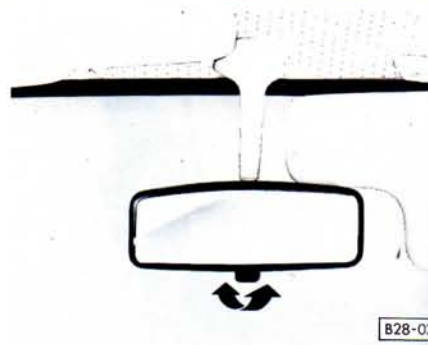

### Ant-dazzle interior mirror\*

With this lever the mirror can be set the anti-dazzle position:

Lever forward – Normal setting  
Lever to rear – Anti-dazzle setting

It is important when setting the mirror ensure that the lever on lower edge of mirror is pointing forward.

## SEAT BELTS

It has been proved that seat belts give good protection in accidents. In most countries therefore the wearing of seat belts is required by law.

Put your belt on before every journey – also in town traffic.

All vehicle occupants should also always wear the seat belts – including those on the rear seats.

Even pregnant women should always wear a seat belt (preferably the three point type).

The routing of the belt is of major importance to the protective effect of the belt. How the belt should be worn is described on the next pages<sup>1)</sup>.

### Safety for children

Children under 12 years old should normally be carried on the rear seat (Caravelle and Combi) and should, depending on age, be secured there with a child's restraint system or the existing belt.

■ Children up to about 6 years of age should, depending on size be carried in a reclining safety seat or a child's seat.

■ Children above 6 years of age can also use a lap belt.

■ Babies up to about 8 months old can also be carried on the front passenger's seat in a restraint system specially approved for this purpose.

■ Larger children may use three point belts provided that the belt passes over centre of shoulder and not against the child's neck – see illustration on next page. If necessary, a safety seat cushion can be used.

**The installation and use of child restraint systems must be done in accordance with instructions of the manufacturer concerned.**

### General notes

Only one person is to be secured with each belt. Never secure two people (even children) with one belt.

**On vehicles with armrests\* for the seats, always ensure that the belt runs underneath the armrests.**

The belt should not be worn over hard or breakable articles (glasses, ball pens, key rings, pipes, etc.) because this can cause injury to the body.

Loose, bulky clothing (e.g. overcoats over jackets) affects the fit and function of the belts.

The belt must not be jammed anywhere or rub on any sharp edges.

The slot for the belt tongue must not be blocked with paper or anything as otherwise the tongue cannot engage properly.

The belts must be kept clean as otherwise the retractors may not work properly (see also "Care and Maintenance" section).

<sup>1)</sup> In some export countries the belts fitted may differ from the belts described here.

Seat belts which are damaged or have been stressed in an accident and stretched must be replaced – preferably by a V.A.G workshop. The anchorages should also be checked.

Belts can be service installed for all seating positions on vehicles not fitted with belts at the factory. The installation of belts should be done by a V.A.G workshop because these workshops have the information necessary to do the job properly.

### Note

On the Van there are no belt anchorages in the load compartment.

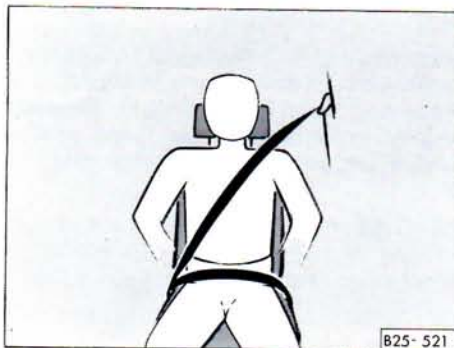

### Three-point inertia reel belts\*

The inertia reel belt gives complete freedom of movement when pulled slowly. Sudden braking however will cause the belt to lock.

The retractor mechanism will also lock the belt when accelerating, driving down steep gradients or cornering hard.

### Putting belt on

Pull the tongue slowly and smoothly across your chest and hips and push it into the lock part fitted on the seat until tongue engages audibly (pull to check).

**The shoulder part of the belt must run roughly across the centre of the shoulder as shown – on no account against the neck, and be firmly in contact with the body.**

On the front seats the routing of the shoulder belt can be altered by installing a belt anchorage height adapter.

**The lap part of belt must always fit tightly across the lap. Pull belt tight if necessary.**

Particularly in the case of pregnant women the lap part of the belt should be as low across the lap as possible so that no pressure is exerted on the abdomen.

**The belt must not be twisted.**

**The backrest of the front seats must not be inclined too far to the rear as otherwise the belts are no longer effective.**

### Taking belt off

To release the belt, press the orange-coloured button in the lock. The tongue will then spring out.

Pass the tongue towards the door by hand so that the retractor can roll the belt up properly.



### Belt height adjustment

Two anchorage points are provided in the cab for the upper belt attachment. This makes it possible to adapt belt to body size.

### Lap belt\*

The buckle is used in the same way as on the three-point inertia reel belts.

**The belt must always fit tightly across the lap.**

**To lengthen belt** hold the tongue at right angles to belt and pull belt through to the required length.

The belt is easier to adjust if tongue and cap are pressed together.

**To shorten belt** it is only necessary to pull the free end of belt.

The surplus belt length is taken up by moving the plastic slide.

### Two-point inertia reel belts\*

The individual seats\* in the passenger compartment are fitted with two point inertia reel belts. They give complete freedom of movement when pulled slowly but sudden braking however will cause the belts to lock. The automatic retractor mechanism will also lock the belt when driving down steep gradients or cornering hard.

#### Putting belt on

Pull the tongue slowly and smoothly across the hips and push it into the lock part fitted on the seat until tongue engages audibly (pull to check).

**The belt must not be twisted. The belt must always fit tightly, pull belt up slightly if necessary.**

#### Taking belt off

To release the belt press the orange coloured button in the lock. The tongue will then spring out.

Pass the tongue across by hand so that the retractor can roll the belt up properly.

## HEAD RESTRAINTS\*

The head restraints must be adjusted properly to suit the body size. Only correctly adjusted head restraints, together with the seat belts, provide effective protection.

### Adjusting height

Grip at sides with both hands and pull up or push down. The upper edge should be roughly at eye level.

### Removing and installing

Push spring clips out of slotted rings in backrest with a small screwdriver and lift head restraint out.

To install, first press the spring clips into the guide rings so that the straight part of clip is at the rear. Then push head restraint rods into the guides until they engage audibly.

#### Note:

The spring clips need not be taken out on vehicles which have a rear seat/fully reclining seat bench.

It is quite sufficient to push the protruding spring clip extensions back to the rear, to enable the head restraints to be removed.

## SEATS IN CAB



### Individual driver's and front passenger seats

#### To move seats back or forward

Lift lever (1) on outside of seat and move seat. Then release lever and move seat further so that catch engages.

#### Caution

■ For safety reasons the seats should only be adjusted when vehicle is stationary.

#### To adjust backrest rake

Take weight off backrest, press lever (2) on right side of seat frame down and move backrest to desired position by moving upper part of body then release lever.



#### Caution

■ Do not lower the backrest too far when on the move because the seat belts are then no longer fully effective.

#### Armrests\*

The armrests on the front seats can be hinged up if they are not required.

The angle of the armrests can be adjusted as required with a knurled knob underneath the armrest.

#### To take seat out

- Slide seat forward into 1st latch position.
- Lift hook (3) against spring-loading at the same time pull lever (1), hold it and slide seat past stop.
- Release hook and lever and push seat forward out of runners.
- The hook need not be lifted when putting seat back as the seat, with the lever lifted, can just be pushed past the stop.

#### Seat heating\*

Seat cushion and backrest of driver's seat can be heated electrically when ignition is on.

Further details are give under "Switches", page 40.

#### Head restraints\*

The head restraints must be adjusted to body size – see page 15.

## SEATS IN PASSENGER COMPARTMENT\*

### Two seater bench\*

The seat is moved back or forward in same way as the single seats. The lever is at the front of seat.

When seat is moved, the backrest rake is also altered.

#### To remove

Remove in same way as the single seats. Bolts on right and left of backrest must be removed.

### Swivelling seats\*

On vehicles with swivelling seats the passenger's seat can be turned 180° to the right and the driver's seat 90° to the left. To turn seats, push them forward slightly or open door, and pull the release lever. The handbrake must be released before turning driver's seat. **(Engage a gear to prevent vehicle from rolling away.)**

The swivelling seats must always be facing forward when vehicle is in motion.

### Removing and installing centre seat bench

The centre seat is pushed into two runners and secured with four screws. To take seat out the floor covering must be lifted and the screws removed. The seat can then be pulled out of the runners sideways through the opened sliding door.

#### Note

On vehicles with floor carpeting, the securing strip in the sill area must be taken off first and the carpet then lifted carefully. Take care when doing this to ensure that the carpet does not tear at the cut-outs.

### Removing and installing rear bench seat

The rear seat cushion is bolted to the side panels on each side with one bolt under the upholstery. Remove bolts and take lower part of seat out.

The seat backrest is secured at each side with two bolts. The bolts between seats and backrests also serve as seat belt anchorages.

**When refitting the seat and backrest, ensure that the seat belt is also correctly installed.**

## OPERATION

### INDIVIDUAL SEATS IN PASSENGER COMPARTMENT\*

#### Centre seats

The centre seats can be turned and the backrest angle adjusted.

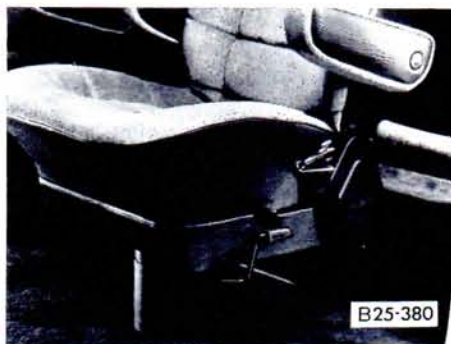

#### Turning

Lift lever (see illustration), turn seat to the desired position and let lever engage again.

If the backrest is very low, it may be necessary to raise it slightly before the seat can be turned.

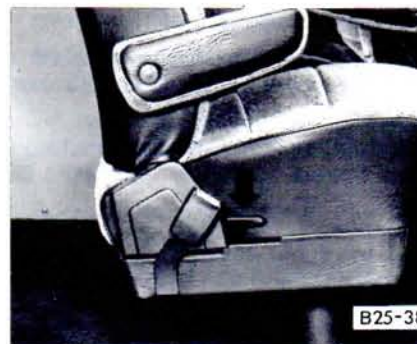

#### Adjusting backrest angle

Take weight off backrest and press lever down (see illustration). Adjust backrest to the desired position by moving up part of body and release lever.

#### Removing

Lift the lever used to turn seat and turn seat out.

The base which remains can be removed when carpet is lifted.

#### Caution

**When the seats are installed again, ensure that base and seats are secured properly.**

## Rear seats

The height, seat angle and backrest angle of the rear seats can be adjusted.

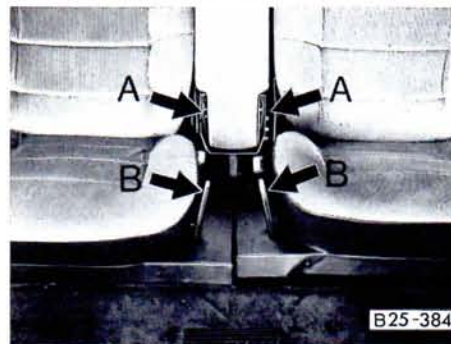

### Mechanical adjustment

#### Adjusting seat angle

Press lever B to front or rear and adjust position of seat as required by moving body weight.

#### Adjusting seat height

Press lever B alternately at front and rear and by moving weight of body to front and rear lift or lower the seat.

#### Adjusting backrest angle

Take weight off backrest and turn knob A at side of backrest.

#### Caution

**When vehicle is in motion, the backrests must not be inclined too far to the rear as otherwise the belts are no longer fully effective.**

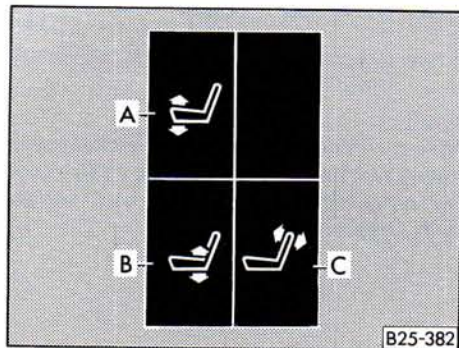

## Adjusting seat height

Press switches A and B at front –  
Seat is raised  
Press switches A and B at rear –  
Seat is lowered

## Adjusting backrest angle

Press switch C at front –  
Backrest moves up  
Press switch C at rear –  
Backrest moves down.

## Electrical adjustment\*

### Adjusting seat angle

Press switch A at front –  
Front of seat is raised  
Press switch A at rear –  
Front of seat is lowered

Press switch B at front –  
Seat is raised at rear  
Press switch B at rear –  
Seat is lowered at rear.

## Caution

When vehicle is in motion, the backrests should not be inclined too far to the rear otherwise the seat belts are no longer fully effective.

## REAR SEAT/FULLY RECLINING SEAT BENCH\*



The rear seat/reclining seat bench can be converted into a large sleeping area. Before doing this, the backrests of the center row of seats must be tipped forward. The latching levers are located on the outsides of the right and left hand backrests.

### To convert reclining seat bench

- Remove head restraints\* – see page 15.
- Unlatch the backrest with the release grip on the reverse side of the backrest, and fold the backrest forwards.

■ By pulling the release grip further towards the front, the backrest and seat bench are pulled in a forward direction.

■ Finally, fold the seat backrest fully to the rear to form a flat sleeping area.

### Returning seat bench to original position

- Pull the seat backrest upwards out of the horizontal position.
- Slide the seat bench, together with backrest to the rear again.
- Push backrest back into locking position.

■ Pull the seat belts out again between backrest and seat, so that they are in a position for use.

■ Install head restraints\* – see page 15.

The space underneath the seat bench can be used as a storage compartment. For this, it is necessary to lift the seat bench slightly at the front. It will remain in the lifted position when the strut, located on the left on the sliding door side, is swung upwards.

### LUGGAGE COMPARTMENT/ LOAD SURFACE

---

#### To enlarge luggage space\*

- Release backrest by pulling loop
- Fold backrest down to seat

The backrest locks automatically when hinged to the rear.

Instructions on using the rear/reclining seat\* are given on page 21.

#### Notes on using the luggage compartment or the load surface

- The load must be stowed so that it cannot slip or even fly forward when the brakes are applied.
- In the interests of good handling the load should, wherever possible, be carried between the axles. The permissible axle loads and the permissible gross vehicle weight should on no account be exceeded.
- Ensure that the heater element in the rear window is not damaged by articles rubbing against it.

**Never drive with the luggage compartment not properly closed otherwise exhaust gas can be drawn into the body.**

### FOLDING LUGGAGE COMPARTMENT COVER\*

---

The folding cover can be pushed together to front or rear or taken out all together.

When the front part is to be pushed to the rear or the rear part to the front the appropriate rod must be jerked out of the retainers. When the rear rod is pushed fully forward it engages.

#### Notes

**Only light articles of clothing may be placed on the luggage compartment cover.**

Ensure that:

- The cover is correctly located in its mountings when vehicle is moving.
- No items of luggage can fly forward if brakes are applied sharply.
- The heater element in the rear window is not damaged by articles rubbing against it.
- Vision through rear window is not obstructed otherwise a second outside mirror must be fitted.

### ROOF RACK

---

When a roof rack is to be used, note the following:

- Only use roof racks which are supported in the rain channel
- Distribute load uniformly. Do not exceed permissible roof load or permissible gross vehicle weight. Further details on pages 127-129.
- When carrying heavy or large objects on the roof, bear in mind that the vehicle handling changes due to the alteration in centre of gravity and the increased area exposed to the wind. Driving style and speed must be modified to allow for this.



**COVER\*** (Pick-up)

The cover must be secured properly behind the cab.

The cover is correctly secured when the rod incorporated in the cover engages in the rain channel at the rear of the cab and the left and right hand ends are bolted to the canopy frame.

When the cover and rails have been removed, care should be taken when refitting to ensure that the foam seal is stuck properly in the rain channel (if necessary renew seal).

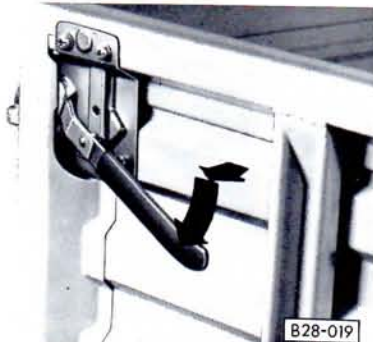
**DROPSIDES** (Pick-up)

To drop side boards – pull handle outwards to release locking pin and swing down to lift hook.

**On vehicles with support cables for the tailboard, not more than 150 kg should be placed on the tailboard when it is down.**

**HANDBRAKE**

The handbrake is located between the front seats.

To apply the handbrake pull lever up firmly. On hilly roads the 1st gear or on automatic gearboxes the parking lock, should also be engaged. The handbrake should always be applied so firmly that it is not possible to drive off accidentally with handbrake slightly on.

When handbrake is applied with the ignition on, the brake warning lamp\* comes on.

To release handbrake, pull lever up slightly, press locking knob in and push lever right down.

# OPERATION

## MANUAL GEARBOX

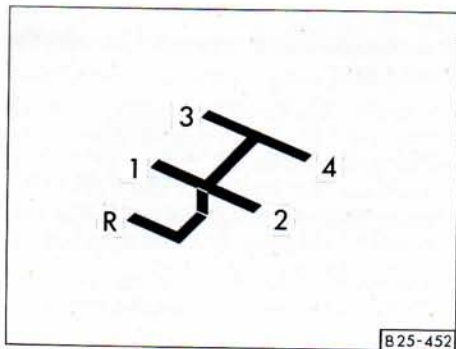

### 4 speed gearbox

#### Engaging reverse

Move lever in neutral to the left, press it down and move it further to the left stop and then push it forward.

Only engage reverse gear when vehicle is stationary.

When engine is running, depress clutch fully and wait a few seconds before moving gear lever, to prevent grating noises.

When reverse gear is engaged with ignition on, the reversing lights\* come on.

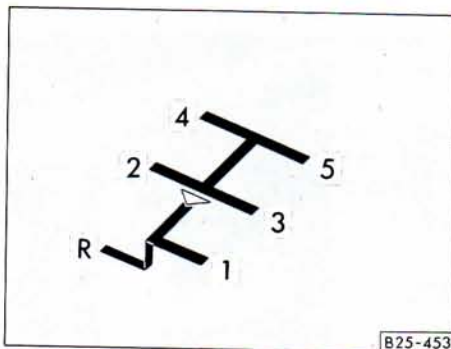

### 5 speed gearbox\*

**To engage 1st gear** move lever past pressure point to left stop and then pull it back.

One normally moves off in 1st gear but on vehicles with the 44, 57 and 82 kW engine and 5 speed gearbox the rear axle ratio is different so that one can move off on the level with a light load in 2nd gear.

**To engage reverse gear** move lever past pressure point to left stop, press it down and push it to front.

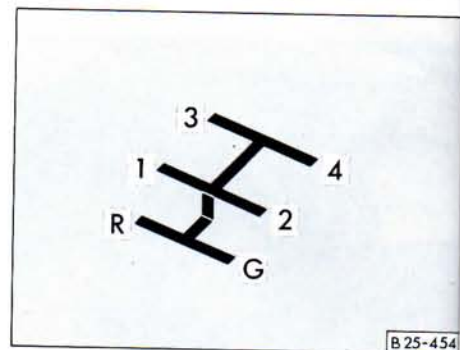

### 4 + G gearbox (syncro)

#### Engaging crawler gear (G) on syncro

Move lever in neutral to the left, press it down and move it further to the left stop and then pull it to the rear.

#### Note

When driving you should not rest your hand on the gear lever. The pressure of your hand is transmitted to the shift forks in the gearbox and can cause premature wear of the forks.

## DIFFERENTIAL LOCKS\*

When negotiating a curve, the wheels of a vehicle cover different distances. To balance out the differences in wheel speeds, differentials are incorporated in the driving axles. However, these differentials have a distinct characteristic: As soon as one wheel on an axle commences to spin on a slippery surface, only very little traction is available, even though the other wheel is on a hard surface.

Using the differential locks the wheels of one axle can be locked together and the traction is once again obtained.

On the Transporter/Caravelle there are two different types of differential lock: Vehicles with rear wheel drive have a limited slip differential in the rear axle and 4 WD vehicles (syncro) have selectable mechanical locks in front and rear differentials.

### Limited slip differential\*

(Rear wheel drive)

The locking effect is obtained by means of plates which are arranged in the differential as a sort of multi-plate clutch. With this differential the locking effect is not 100% but only approx. 45%. Contrary to vehicles with 100% locking, the steering behaviour on the road, particularly in sharp curves, remains almost unchanged.

The effective locking force is dependent on the speed difference of the two driving wheels. This means: the larger the difference, the larger is the locking force of the differential.

### Driving tips

In normal conditions the vehicle can be driven just like every other vehicle. At the beginning it may take a bit of getting used to when driving through sharp curves. This is due to the fact that a slight locking effect is always present.

Furthermore in isolated borderline conditions where, on the one hand the frictional resistance of the driving wheels on the ground differs a great deal and, on the other hand, a large amount of power must be transmitted to move off, it may be found that the maximum possible locking effect is not obtained in the differential. One notices this because one wheel spins while the other does not turn at all. In this case one should engage and disengage the clutch gently and repeatedly. This will prevent the differential from becoming overheated.

### Gear oil

The oil level does not need checking between the intervals given in the Service Schedule. The oil also does not need changing. To top up or fill after a repair a V.A.G workshop should be contacted because the gearbox must be filled with a special oil.

## Selectable differential locks\* (syncro)

With the selectable differential locks, the wheels on one axle are fully locked together (100%). As no compensation takes place when cornering, the handling and steerability are affected – particularly in the case of the front differential lock.

### Attention

**The differential locks may only be used under the limited specific conditions described on the following pages.**

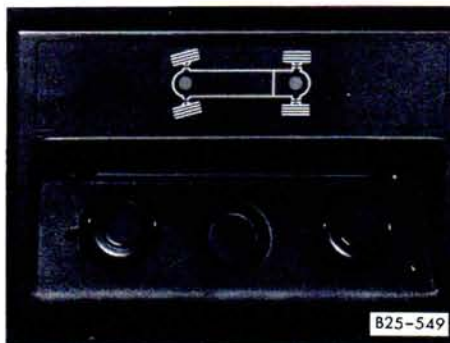

### Engaging the differential locks

The differential locks are engaged and disengaged with the knobs shown in the centre of the instrument panel with vehicle stationary or moving.

**Left knob** – Front axle differential lock

The knob for the front differential lock is secured so that it cannot be pulled unintentionally. The knob must therefore be turned to the right before it is pulled out.

**Right knob** – Rear axle differential lock

When the knobs are pulled/pushed engagement or disengagement is only selected. The actual shifting process can be delayed. If the wheels are rotating at different speeds, or if the drive train is under strain, e.g. tight corner with differential lock engaged, it could even happen that the lock will not engage or disengage at all. In such a case throttle application should be reduced and the vehicle should be driven straight ahead while moving steering wheel slightly to enable the lock to engage/disengage.

The warning lamps above the knobs indicate the operational condition of the locks:

- If the front axle differential lock has been selected, the left hand warning lamp flashes. As soon as the lock engages the lamp lights up continuously.
- The right hand warning lamp monitors the function of the rear axle differential lock. It does not flash when the lock has been selected but only lights up once the lock has engaged properly.

■ Both warning lamps go out again once the knobs have been pushed in and the locks have actually disengaged.

If after selecting the differential locks, and after driving some distance, the warning lamps do not light up, the electrical system and the locks themselves should be checked at a V.A.G workshop.

### Attention

The differential locks influence the steerability of the vehicle. In particular, with the front axle differential lock engaged, the vehicle is no longer steerable. For this reason, the front axle differential lock must only be used under offroad conditions and then only at low speeds. Always disengage the lock before driving on metalled road surfaces.

### When may the differential locks not be engaged?

■ Neither the front nor the rear axle differential locks may be engaged when driving along metalled road surfaces.

Locking the front axle differential makes the vehicle unsteerable.

When the rear axle differential is locked, the rigid connection between the two rear wheels has a scrubbing effect on the tyres when cornering. This leads to increased tyre wear and also to "jerking" when the vehicle is being steered. In certain circumstances it may even damage the drive train.

For this reason, the locks may only be engaged under off-road conditions or as an assistance when moving off.

See "Driving Tips" on page 65 also.

■ When a wheel is spinning, if for example the vehicle is stuck in snow. This would not only lead to increased tyre wear but it could also damage the drive train and lead to uncontrollable acceleration. For this reason, the spinning wheel must first be brought to a standstill before the differential locks are engaged.

■ When the vehicle is being towed – see page 112 also.

■ When testing the vehicle on a dynamometer, e.g. when being tested by local authorities – see page 67 also.

## AUTOMATIC GEARBOX

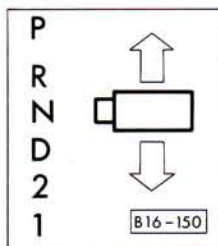

### Selector lever positions

#### P – Parking lock

The driving wheels are locked mechanically.

The parking lock may only be engaged when vehicle is standing still. To move lever into and out of the "P" position the safety catch in lever handle must be pressed.

Depending on vehicle version, there may also be an additional electrical selector lever safety catch. The lever can then only be moved out of the P position when the **brake pedal** is depressed and the knob in the selector lever pressed.

#### R – Reverse gear

The reverse gear must also be engaged when vehicle is stationary and the engine idling. Before "R" can be engaged the safety catch in lever handle must be pressed.

#### N – Neutral

#### D – Normal driving position

The three forward gears are shifted up and down automatically according to throttle opening and road speed.

#### 2 – Position for hilly stretches

The 1st and 2nd gears are shifted up and down automatically according to throttle opening and road speed. The 3rd gear is not used. This increases the engine braking effect.

The road speed must not exceed 90 km/h (56 mph).

The lever can be moved from "D" into "2" with accelerator pedal depressed. However as the shift into 2nd gear takes place immediately this must **only be done at speeds below 85 km/h.**

#### 1 – Position for steep hills

To engage this gear, the catch in lever handle must be pressed. The vehicle remains in 1st gear and 2nd and 3rd gears are not used. This gives maximum possible engine braking effect. The road speed must not exceed 50 km/h (30 mph).

The lever can be moved from "2" into "1" with accelerator pedal depressed. However as the shift into 1st gear takes place immediately this must **only be done at speeds below 45 km/h.**

#### Kick-down device

The kick-down device gives maximum acceleration. When the accelerator pedal is pressed right down past the full throttle position, depending on road speed and engine speed, either the up-shift is delayed (forced throttle) or the box changes down into the next lower gear.

## Notes on driving

### Starting

The engine can only be started when selector lever is at "N" or "P". See also "Starting engine" on page 31.

### Selecting a driving range

**Before selecting a gear with vehicle stationary and engine running, always operate footbrake. This also applies when moving lever from "P" to "N".**

Depending on vehicle version, there may also be an additional electrical selector lever safety catch. The lever can then only be moved out of the P position when the **brake pedal** is depressed and the knob in the selector lever pressed.

**Particularly when the idling speed is high (after starting from cold) it is necessary to hold the vehicle with the handbrake.**

This is necessary because with an automatic gearbox the transmission of power is not completely stopped even at idling speed – the vehicle tends to "creep".

**When selecting a gear with vehicle stationary, do not depress accelerator.**

**When a driving range is selected with the vehicle stationary, the throttle must on no account be opened (e.g. by hand from engine compartment). The vehicle will otherwise move immediately – possibly even with handbrake applied.**

**Before working on the engine when it is running, place selector lever at "P" and apply handbrake.**

**If the lever is moved accidentally into "N" when driving, release accelerator and let the engine speed drop to idling before selecting a forward gear again.**

### Driving downhill in winter

**Before driving down a long slippery gradient after starting from cold in a vehicle with a carburetor engine, ensure that engine is warmed up enough to idle at normal speed. Otherwise the engine braking effect will be limited when accelerator pedal is released and gentle braking on the slippery surface will not be possible.**

### Stopping

To stop vehicle temporarily such as at traffic lights, all that is necessary is to apply the brakes. It is not necessary to move lever to "N". The engine should however only be running at idling speed.

### Parking

On level ground all you need do is to apply the handbrake. On a gradient the handbrake should be applied firmly first and then the parking lock engaged. This will ensure that the locking mechanism is not too heavily loaded and makes lock easier to disengage.

### Tow starting

On vehicles with an automatic gearbox the engine cannot be started by towing or pushing the vehicle.

When battery is flat, the engine can be started from the battery of another vehicle by using a jumper cable. See "Emergency starting", page 111.

### Towing

If the vehicle has to be towed at any time, you must read the instructions in the section "Towing" on page 112.

## STEERING LOCK/IGNITION SWITCH

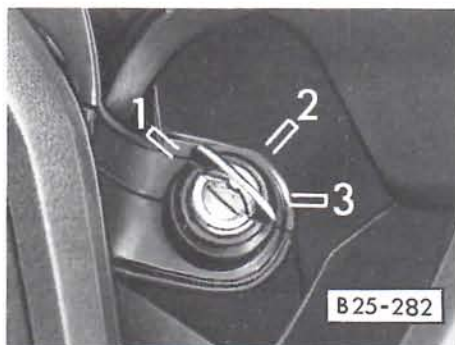

### Petrol engine

- 1 - Ignition off - Steering can be locked.
- 2 - Ignition on
- 3 - Starting engine

### Diesel engine

- 1 - Fuel supply cut off - Steering can be locked
- 2 - Glow and drive position  
While glow plugs are on, no other heavy current consumers should be switched on.
- 3 - Starting engine

### For all vehicles:

#### Position 1:

To lock the steering wheel withdraw key and turn wheel until you hear the pin engage.

#### Caution

**Do not withdraw key until vehicle is stationary.**

#### Position 2:

If the key is difficult to turn in the lock or cannot be turned to this position at all, the steering wheel must be turned to and fro slightly to release the locking pin.

#### Position 3:

In this position the headlights, the wind-screen wipers, the blower and the heated rear window\* are switched off.

Before the starter can be operated again the key must be turned back to position 1. The non-repeat lock in the ignition switch prevents the starter from being operated when engine is running as this could damage the starter.



## STARTING THE ENGINE

### General notes

■ **Be careful when running the engine in a confined space. Danger of poisoning.**

■ Check that gear lever is in neutral. (On vehicles with automatic gearbox: Selector lever at "P" or "N") and apply handbrake firmly before starting.

■ Depress the clutch pedal on vehicles with manual gearbox when starting so that the starter only has to turn the engine.

■ As soon as the engine starts, release the ignition key so that the starter can disengage.

■ After starting a cold engine it may sound noisy briefly because the oil pressure has to build up in the hydraulic tappets\* first. This is normal and no cause for alarm.

■ Do not warm engine up by running it with vehicle stationary. Drive off straight away.

■ Do not overrev or use full throttle until the engine has reached the normal operating temperature.

■ **On vehicles with a catalytic converter the engine must not be started when catalytic converter is at operating temperature by towing the vehicle a long distance as otherwise unburnt petrol can get into the catalytic converter and be burned there – see also page 83.**

### 44 and 57 kW carburetor engines

#### Starting a cold engine

The carburetor is fitted with an automatic choke which is actuated the first time the accelerator pedal is depressed when engine is cold.

■ Depress accelerator pedal slowly **once (twice when it is freezing)** and then release it.

■ Start engine – **do not use accelerator.**

■ If the engine does not start at once, stop using starter after 10 seconds, wait about half a minute and then try again.

■ The increase in the idling speed which takes place as engine starts to warm up can be reduced by just tapping the accelerator pedal briefly.

**On vehicles with an automatic gearbox** the engine should be run at fast idling speed for about one minute after starting when it is very cold.

The pedal should then be tapped so that the speed drops and a gear can be selected at normal idling speed.

#### Starting a warm or hot engine

■ Depress pedal slowly **while operating** starter and hold it in the full throttle position – do not pump the pedal!

■ Release pedal as soon as engine starts.

### Fuel injection engines

The engine is fitted with a fuel injection system which automatically supplies the correct fuel/air mixture for all operating conditions. The starting procedure described here is applicable regardless of ambient or engine temperature:

- Start engine – **do not depress accelerator.**
- Only if the engine does not start the first time, should the accelerator pedal be depressed slowly during the next attempt to start. When engine starts release accelerator pedal immediately.

### Diesel engines

#### Glow plugs

The engine is fitted with glow plugs. The time the plugs are on is indicated by a lamp which is controlled by the coolant temperature – see page 33.

#### Cold starting aid

To facilitate starting from cold, there is a cold starting device in the injection pump.

The cold starting device is actuated when the knob on the right of the steering column is pulled out fully.

#### Starting a cold engine

- The knob of the cold starting device should be pulled out **fully** before operating starter regardless of the ambient temperature.
- Turn ignition key to position 2, glow plug lamp comes on. It goes out when the ignition temperature is reached (see page 30).

If the warning lamp does not come on when engine is cold, there may be a defect in the glow plug system – get expert assistance.

**To avoid draining battery unnecessarily, do not switch any other heavy current consumers on while glow plugs are on.**

- As soon as lamp goes out, start engine. Do not depress accelerator while starting.

If engine only fires irregularly, continue to operate starter a few seconds longer (15 seconds at maximum) until engine runs under its own power.

If engine does not start, switch glow plugs on again and try starting it again as described.

If the engine still does not start the fuse for the glow plugs may have blown – page 103.

---

■ Push the knob of cold starting aid in fully as soon as the engine has reached normal operating temperature.

### Starting a warm engine

The glow plug warning lamp does not come on – the engine can be started straight away.

Do not pull cold starting aid knob and do not depress accelerator pedal.

### STOPPING ENGINE

---

■ **When vehicle has been driven hard for a while do not switch engine off as soon as you stop. Let it idle for about 2 minutes to cool it down slightly.**

■ When engine is hot, the fan may continue to run when engine has been stopped or it may switch on suddenly – even when ignition has been switched off.

## WARNING LAMPS

The layout of the warning lamps depends on the model and the engine fitted. The symbols shown here are also on the actual warning lamps.

### - Engine oil pressure

This warning lamp flashes when the ignition is switched on. After the engine has started, the lamp must go out again.

If the warning lamp does not go out, or flashes when driving – at an engine speed of approx. 2000 rpm a buzzer then sounds – **stop at once and switch engine off**. Check the oil level and if necessary, add oil – see page 74.

If the lamp comes on despite the oil level being correct, **do not drive on**. In such a case, **the engine must not be run**, even at idling speed – call in expert assistance.

### Note:

The oil pressure warning lamp is not an oil level indicator.

### - Generator

#### Petrol engines

This lamp comes on when the ignition is switched on and should go out when the engine is started.

If the lamp comes on when driving, **stop at once, switch engine off** and check vee belt.

If the belt is broken do not drive further because the coolant pump is then no longer being driven. Fit a new belt. (For belt sizes see "Technical data".)

If the warning lamp comes on although the belt is not broken one can normally drive on to next V.A.G workshop.

However as the battery is then discharging continuously, all electrical components which are not absolutely essential should be switched off.

#### Diesel engine

This lamp comes on when the ignition is switched on and should go out when the engine is started.

If the lamp comes on **when driving**, stop at once, switch engine off and check the vee belts for generator and coolant pump.

If the belt for the coolant pump is broken, do not drive further. Renew the belt – for belt size see "Technical data".

If the belt for the generator is broken the vehicle can still be driven to the next V.A.G workshop but the battery will then discharge continuously – see next paragraph.

If the belts are not broken one can normally drive on to the next V.A.G workshop. As the battery will be discharging continuously, all electrical components which are not absolutely essential should be switched off.

 – **Glow plugs**

(Diesel engine only)

When engine is cold, the warning lamp comes on when key is turned to drive position (ignition on).

If the warning lamp does not come on, there may be a defect in the glow plug system – get expert assistance.

When the lamp goes out, start engine immediately – see page 32.

When engine is warm the glow plug lamp does not come on – the engine can be started straight away.

 – **Turn signals**

The warning lamp flashes when turn signals are switched on. If a turn signal fails, the warning lamp flashes twice as fast. (Not when towing a trailer). Further details are on page 41.

 – **High beams**

The warning lamp comes on when high beams are on or headlight flasher is used.

 – **Coolant temperature/  
coolant level**

This lamp flashes for a few seconds as a functional check when ignition is switched on.

If the lamp does not go out afterwards or flashes when driving, either the coolant temperature is too high or the coolant level is too low.

**Stop at once, switch engine off** and check if the radiator fan is running (by listening). The fan is at the front behind the radiator grille. If the fan is not running, check fuse and replace if necessary – see page 102.

If the fan is in order, check coolant level and top up if necessary.

**Caution. Danger of scalding. Before removing the cap, let engine cool down.**

For further details see page 78.

If the warning lamp does not go out even though the coolant level, and fan fuse are in order, **do not drive further** – get expert assistance.

If the trouble is only caused by the fan and assuming coolant level is in order and warning lamp is out – one can drive on to the next V.A.G workshop. In order to make a good use of the air stream for cooling do not let engine idle or drive very slowly.

**Trailer turn signals\***

The warning lamp flashes when turn signals are switched on when towing a trailer.

If a turn signal fails on trailer or vehicle, the warning lamp does not flash.

**Differential locks\***

Warning lamps for the differential locks on four wheel drive models – see page 26.

### (!) – Brake system

The warning lamp\* comes on when

- the handbrake is applied
- the fluid level is low

**If the lamp does not go out when handbrake is released or comes on when driving, the fluid level in reservoir is too low. If at the same time the pedal free travel increases, one of the two hydraulic circuits may have failed.**

**You can drive on to the nearest V.A.G workshop but allow for higher pedal pressures and longer braking distances on the way.**

### (ABS) – Anti-Locking Brake System (ABS)\*

The warning lamp comes on when the ignition is switched on. It goes out, when engine has been started and the generator warning lamp has gone out. (When a vehicle speed of approx. 6 km/h has been reached, an automatic check sequence takes place. During the check a pump motor noise may be heard.)

If the lamp does not go out, or if it comes on while driving the system is not in order. The vehicle can then only be braked with the normal brake system and should be taken to a V.A.G dealer as soon as possible.

Further detail on ABS is given on page 83.

## INSTRUMENTS

The arrangement of the instruments depends on the model concerned and the engine fitted – see also "Instrument panel", page 4.

### Speedometer

The permissible maximum speeds in the gears during the running-in period are given on page 56.

### Mileage recorder

The last figure of the mileage recorder or **trip recorder\*** indicates 100 m or 1/10 mile.

The trip recorder can be set back to zero by pressing the knob in the speedometer dial.

**Clock\*****Normal clock**

To set the time, press knob in centre of dial and turn hands.

**Digital clock**

The time is set with buttons on left and right of dial. The left button is for the hours and the right one for the minutes:

- If pressed briefly, preferably with a ball pen, the time changes one hour or on minute.

- If pressed continuously the hours or minutes change continuously.

With the minute button the clock can be set exactly to the second.

- Press button until time is one minute before time to be set.

- Press button at the moment when the seconds indicator of an accurate clock shows a full minute or when the time signal is heard on the radio.

**Rev counter\***

The dotted zone on the scale shows the maximum engine speed permitted briefly when engine has been run in and is warm. It is advisable to change up or reduce engine speed at the latest by the time the needle reaches this zone.

**Changing up in good time helps to save fuel and keeps the noise down.**

Always change down to the next lower gear before the engine starts labouring. (no longer pulls smoothly).

The green or green shaded area on the scale shows the speed at which the engine is developing its most favourable torque.

The permissible engine speeds during the running-in period are given on page 56.

**Tachograph\***

In many European countries the installation and use of a tachograph is obligatory for certain vehicles.

Details of the regulations can be obtained from local vehicle licensing authorities.

The operation of the tachograph is described in a special leaflet from the tachograph manufacturers.

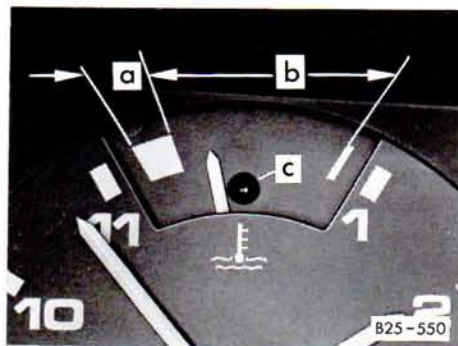

 - **Coolant temperature gauge**

The gauge starts to work when ignition is switched on, but it takes a little time before the needle reaches the final position.

When ignition is switched on the warning lamp (c) flashes for a few seconds as a functional check.

### a - Cold zone

Avoid high engine speeds and do not work engine too hard yet.

### b - Normal zone

When vehicle is driven normally the needle should settle down in this zone.

When engine is working hard and ambient temperature is high, the needle may move well over to the right.

**This is not serious as long as the warning lamp (c) does not flash.**

### c - Warning lamp

If the lamp flashes when driving either the coolant temperature is too high or the coolant level is too low. Stop at once, switch engine off and try to find the cause of the trouble - see page 35.

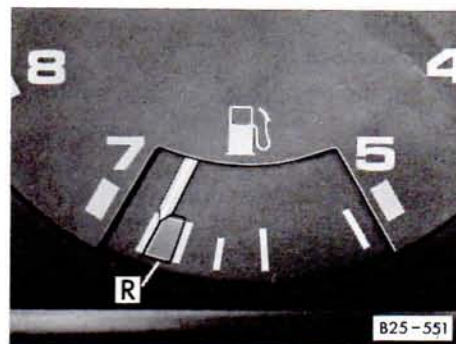

 - **Fuel gauge**

The fuel gauge needle starts to move when the ignition is switched on but it takes a few seconds to reach its final position.

The tank holds about 60 litres (syncro 70 litres).

When the needle reaches the start of the reserve mark (R) there are about 10 litres of fuel left in the tank.

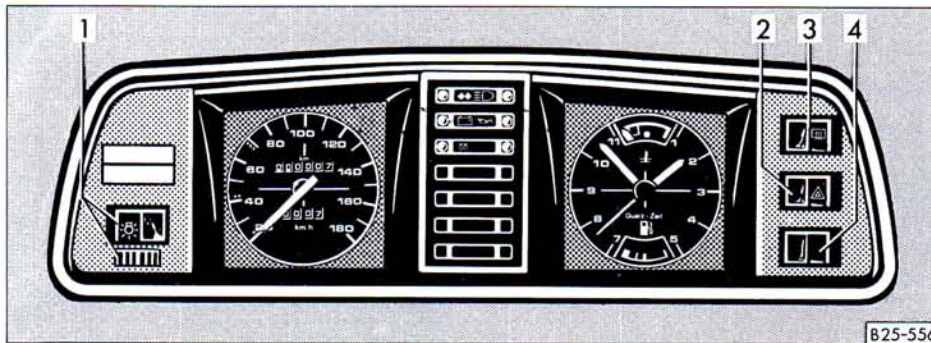

## SWITCHES

**1 – Lighting switch**

First detent – side lights<sup>1)</sup>  
 Second detent – headlight high or low beams

The headlights only work when the ignition is on. When the engine is being started, the headlights are switched off automatically.

When the lights are on, the level of the instrument lighting can be regulated by turning the knurled disc\* below the switch.

Dipping and flashing headlights – see page 41.

On vehicles with additional headlights in the radiator grille\*, these come on together with the high beams.

**2 – Emergency lights**

When the emergency lights are on, a warning lamp in the switch flashes as well.

The system also works when the ignition is switched off.

<sup>1)</sup> On vehicles for Great Britain (depending on model) the headlights also come on with reduced brightness (Dim-dip lighting) at the first detent when the ignition is switched on.

**3 – Heated rear window\***

The heating works only when ignition is on. When heater is on a lamp in the switch lights up.

As soon as window is clear, switch element off. The reduced current consumption helps to reduce the fuel consumption – see also "Driving economically".

On vehicles with electrically adjusted exterior mirrors the mirror surface is heated whenever the rear window heating is switched on.

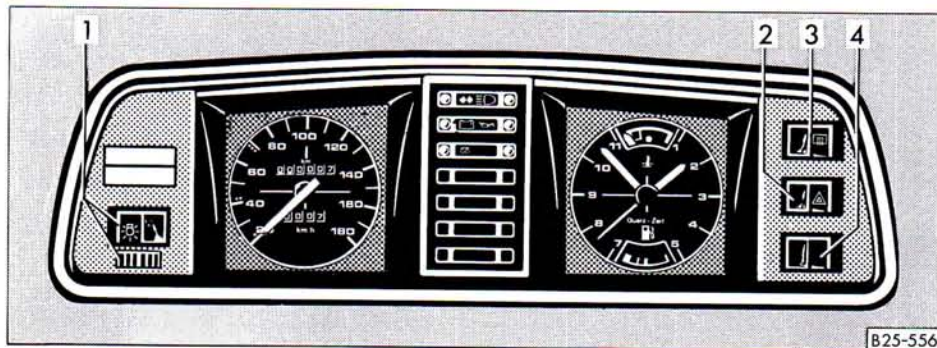

## 4 – Fog lights\* rear fog light\*

- First detent – fog lights
- Second detent – front and rear fog lights,  
or only rear fog light.

At the second position a warning lamp in the switch comes on.

The **fog lights** work only with the side lights (ignition on), low or high beams.

The **rear fog light** works only with the fog lights or with the low or high beams.

### Note

The use of the lighting described at 1, 2 and 4 is subject to local regulations.

## Knurled disc for seat heating\*

The cushion and backrest of the driver's seat can be heated electrically when the ignition is on.

The heating is switched on and regulated with the knurled disc.

To switch heating off, turn knurled disc to the detent position.

## TURN SIGNAL AND DIP LEVER



The turn signals only work when the ignition is switched on.

Right turn signals – lever up  
Left turn signals – lever down

When turn signals are working the warning lamp flashes as well. See also page 35.

On vehicles with additional headlights in the radiator grille\*, these come on together with the high beams.

When a turn signal fails, the warning lamp flashes roughly twice as fast.

The turn signals cancel automatically after making a turn.

**To signal a lane change**

Move lever up or down to pressure point and hold in position – the warning lamp must also be flashing.

**To dip headlights**

Pull lever past pressure point towards steering wheel. When high beams are on<sup>1)</sup>, a warning lamp in the dash lights up.

**Headlight flasher**

Pull lever towards steering wheel to pressure point – the high beam warning lamp lights up.

**Parking lights\***

The parking lights only work when ignition key is removed.

Right parking lights – lever up  
Left parking lights – lever down

<sup>1)</sup> On vehicles for Great Britain (depending on model) the headlights also come on with release of the parking lights at the first detent when the ignition is switched on.

## CRUISE CONTROL SYSTEM\*

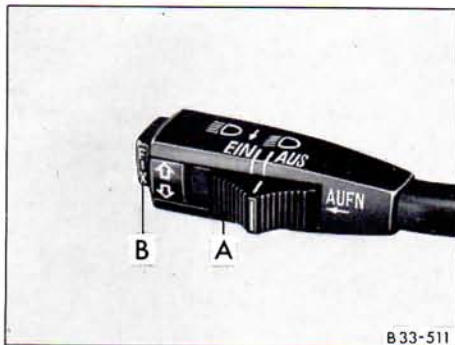

With this system any desired speed from about 35 km/h can be held constant (insofar as engine output permits).

This means that the driver does not have to keep the accelerator constantly depressed on long journeys.

### Caution

■ The cruise control system should not be used in dense traffic and poor road conditions (slippery surfaces, aquaplaning, gravel).

■ When system is switched on do not move into neutral at speeds above 30 km/h without depressing the clutch pedal as otherwise engine will race and can be damaged.

The system is **operated** with the sliding button A and the press button B on the turn signal lever.

The system is **switched on** by moving button A to EIN.

When the speed to be maintained has been reached the press button B must be pressed briefly. The foot can then be taken off the accelerator pedal.

The programmed speed can also be increased without pressing the accelerator pedal. The press button B need only be pressed until the desired speed has been reached.

The speed can also be increased in the normal way with the accelerator pedal. When the pedal is then released the previously programmed speed is resumed.

The system is **temporarily switched off** when brake or clutch pedals are used or when speed is considerably below programmed speed i. e. when driving up a steep gradient in too high a gear.

To resume speed previously programmed when brake or clutch pedals are released or at end of gradient, push button A to the left (AUFN).

### Caution

**The programmed speed must only be resumed when it is not too high for the existing traffic conditions.**

The system is **completely switched off** by moving the switch to the right (AUS) or by switching the ignition off.

## WINDSCREEN WIPER AND WASHER SYSTEM

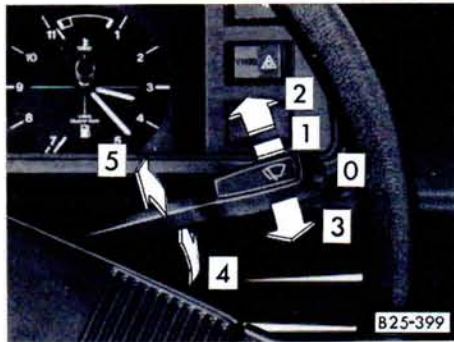

Wipers and washers only work when ignition is switched on.

When it is freezing, check that the wiper blades are not frozen to the glass before switching wipers on for the first time.

**Windscreen**

**Brief wipe:** Lift lever to pressure point before stop 1.

**Wiper slow:** Lever at position 1.

**Wiper fast:** Lever at position 2.

**Windscreen washer**

Pull lever towards steering wheel – the system works as long as lever is held in this position.

**Automatic wash/wipe facility\***

Pull lever towards steering wheel – wipers and washer work.

Release lever.

The washer stops and the wipers carry on for about 4 seconds.

Lever at detent 3

The wipers work about every 6 seconds. (intermittent wipe)

**Rear window****Automatic wash/wipe\***

Press lever briefly away from steering wheel – the wiper works about every 6 seconds (intermittent wipe). Pressing lever briefly again switches the wiper off.

Press lever away from steering wheel, and hold in position –

The wiper and washer work as long as lever is held in position.

Release lever –

The washer stops and the wiper carries on for about 4 seconds.

**Headlight washer system\***

When the headlights are on, the lenses are washed every time the windscreen is washed.

At regular intervals such as when filling the tank, caked on dirt and insects should be removed.

Filling washer container, see page 80.

# OPERATION

## HEATING AND VENTILATION

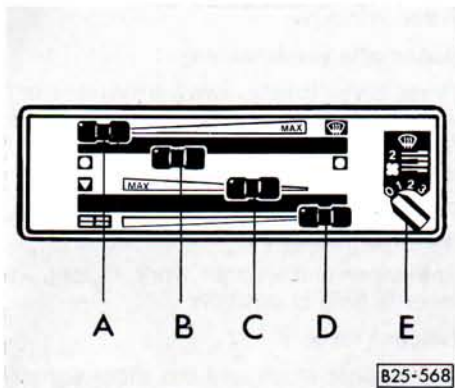

### Controls

#### Levers A and C – Warm or fresh air distribution

Lever A to right – vents 1 and 2 are opened

Lever C to left – vents 4 and footwell vents in passenger compartment\* are opened.

#### Lever B – Heat output

To right – increases

To left – decreases

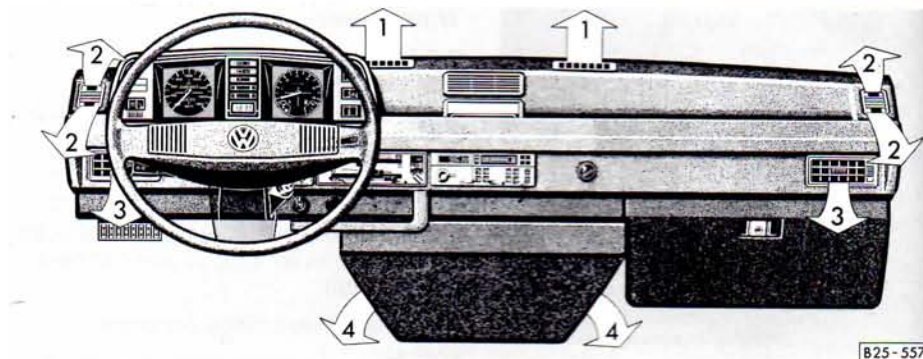

#### Lever D – Roof vents in passenger compartment\*

To right – fresh air decreases

To left – fresh air increases

#### Note:

To distinguish better from the other levers, there are small knobs on levers B and D which can be distinctly felt.

#### Switch E – Blower

The blower has 3 speeds.

### Air vents

Depending on the position of the lever heated or unheated fresh air flows from all vents.

The vents 3 can also be opened and closed separately:

knurled disc downwards – vent opened

knurled disc upwards – vent closed

By swinging the complete outlet grille of vents 3 the air flow can be moved vertically.

When the lever in the grille is moved to and fro, the air flow direction is altered

### Defrosting windscreen and side windows

- Move all levers fully to the right.
- Switch blower to stage 2 with switch E.
- Switch off blower of additional heat exchanger\*.

### Demisting windscreen and side windows

When the windows mist up due to high air humidity, e.g. when it is raining, we recommend the following settings:

- Move levers A, C and D fully to the right.
- Move lever B slightly to the right into the heating range, if necessary.
- Blower switch E to stage 2 or 3.
- Close vents 3.

### Heating interior as quickly as possible

- Levers A, B + D fully to the right
- Lever C fully to the left
- Close vents 3
- Switch blower to stage 2 with switch E.

### Heating interior normally

When the windows are clear and the desired temperature has been reached, we recommend the following settings:

- Lever A to the left
- Lever B to the desired heat output
- Lever C to the left
- Blower switch E at stage 1

### Ventilation

When heating is off, fresh air flows from all vents. When heating is on, only from vents 3.

### Notes

- In order to ensure that the heating and ventilation works properly, the blower should always be switched on when driving slowly.
  - To prevent contaminated air from getting into the vehicle, move lever A fully to left and levers C and D fully to right. The vents 3 must also be closed.
  - The heat depends on the engine temperature – the full heat output is therefore only available when engine is warm.
  - All controls except blower switch E can be set to any intermediate position.
  - Depending on vehicle model the stale air can escape either through slots in the front doors or through slots in the rear side windows.
- The slots in the front doors can be opened or closed by means of slides.



## Additional heat exchanger\* for the passenger compartment

The additional heat exchanger is located under the rear seat. The blower is controlled by a 3 stage switch on the dash panel – see left hand illustration.

To obtain warm air from the heat exchanger, the valve on the heat exchanger must be fully open.

To close or open the valve the trim under the rear seat must be removed.

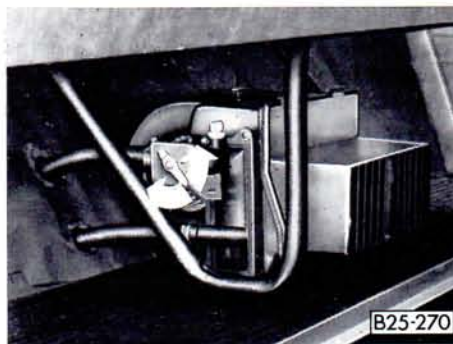

To do this, grip trim on the left side and pull it out. Then move valve lever as shown above.

Lever upwards – opened (Winter position)

Lever to rear – closed (Summer position)

In the warm season the blower of the heat exchanger can be used to circulate the air. When used in this way the valve on the heat exchanger should be closed. This will prevent unnecessary heat radiation reaching the footwell when the weather is warm.



## AUXILIARY AIR HEATER\*

The heater is switched on and off with the knob (see Fig.) in the dash on the right of the steering column. This switch also regulates the amount of heat.

Depending on model concerned the warm air flows from the footwell vents in the passenger compartment and/or from a controllable vent under the driver's seat. The air distribution cannot be regulated.

The heater can be used all the time when vehicle is moving. When engine is not running the heater switches off automatically after about 15 minutes to avoid draining the battery.

The heater is supplied with fuel from the vehicle tank. It can use up to one litre per hour according to operating conditions.

The heat output is about 7 kw (6000 kcal/h).

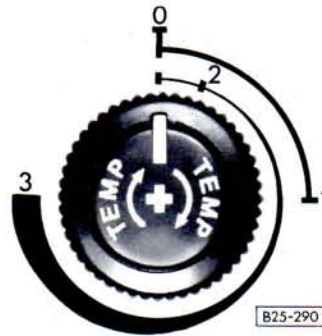

### Switch positions

- 0 – Heater off
- 0 to 1 – Heating with engine not running
- 2 – Heating when driving
- 2 to 3 – Regulates amount of heat

### Heating with engine not running

(Ignition off)

To switch heater on –

Press switch knob in at position 0 and turn it clockwise towards 1 (warning lamp lights up). The knob springs out again when released.

The amount of heat can be regulated between 2 and 3 as required.

Note

On vehicles with Diesel engine it takes about 40 seconds before the heat can be felt.

To switch heater off –

The clockwork in the temperature regulating switch switches the heater off automatically after about 15 minutes and the lamp goes out.

**To switch heater off before clockwork has run down:** turn knob anti-clockwise to 0. The lamp goes out and clockwork runs down.

## Heating when driving

To switch heater on –

Turn switch knob clockwise to position 2 (warning lamp in knob comes on)

The amount of heat can be regulated between 2 and 3 as required.

### Note

On vehicles with Diesel engine it takes about 40 seconds before the heat can be felt.

To switch heater off –

Turn switch knob anti-clockwise to position 0 (warning lamp goes out)

## Notes

■ Every time the heater is switched off, the warm air and combustion air blowers continue running briefly to cool the heater down quicker.

■ To avoid draining the battery, do not run the heater repeatedly when the engine is not running.

■ When the heater is running on the clockwork time switch, it must be switched off by hand before attempting to start the engine at low temperatures so that the full battery capacity is available to turn the engine.

■ **In enclosed spaces and when filling the fuel tank, the heater must be switched off.**

**Due to the risk of fire the heater must not be used when vehicle is parked for instance on dry grass or leaves.**

## Maintenance

When driving through mud and snow, the exhaust pipe may tend to get blocked. Have a look at it occasionally to see that it is clear.

### **According to official German regulation:**

The heat exchanger in the heater is only to be used for 10 years. After this period the heat exchanger must be replaced in a V.A.G workshop. The year in which the heater is first put into operation is marked on the nameplate on the heater.

The V.A.G workshop must then put the date of the repair on the plate on the heat exchanger.

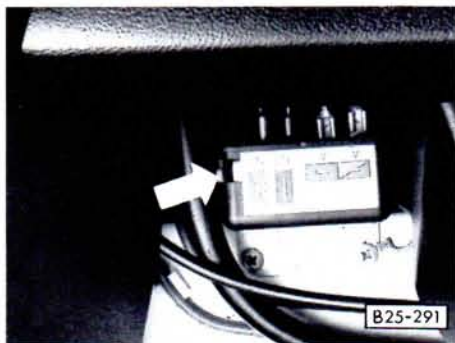

If the heater on vehicles with a **Diesel engine** will not start or stops after operating for a while, an automatic cut-out switches the heater off. If the heater cannot be started by switching the rotary switch off and on, the heater is defective and must be repaired in a V.A.G workshop.

### Fuses

See page 102.

The heater on vehicles with a **petrol engine** has a safety switch which is located under the dash on the left near the steering column. If the heater does not start, or starts and then stops again, wait 3 minutes and then operate the red lever on the safety switch.

If the heater still does not work or if the safety switch stops it again, there is a defect in the heater which can only be repaired by a V.A.G workshop.

## OPERATION

### AUXILIARY WATER HEATER\* (syncro)

The auxiliary heater heats the coolant in the heating circuit and supplies the heat exchanger in the normal heating system and the additional heat exchanger\* for the passenger compartment heating with heated coolant. The coolant circuit of the engine is not heated.

The system is switched off and on or the switch-on time preselected by means of a switch and indicator unit located on the left (or right) under the instrument panel.

Air distribution and regulation is done with the controls of the normal heating and ventilation system (see page 44).

The auxiliary heater can be used with vehicle stationary or when it is moving. When vehicle is stationary, the heater only runs for a maximum of 30 minutes in order to avoid draining the battery. It also switches off automatically when a coolant temperature of 80° C is reached.

When the coolant temperature drops below 70° C the heater is automatically switched on again.



The heater is supplied with fuel from the vehicle tank and uses up to half a litre per hour. The heat output is about 4.5 kw (4000 kcal/h).

#### Controls

- A - Buttons for setting time and preselected time.
- B - Indicator lamp for preselected time
- C - Preselected time
- D - Display
- E - Actual time
- F - Heater on/off
- G - Warning lamp (heater on)

### Setting the time

- Press and hold clock button E.
- Set clock with buttons A.

The display lights up as long as button is pressed. When button is released the display goes out or, if a time has been preselected, the selected time lights up for 2 seconds.

### To switch heater on or off

■ This is done by pressing button F. When heater is switched on the warning lamp G lights up. The heater can only work if the lever for the heat output is pushed fully to the right. This closes an electrical contact.

### Preselecting starting time for heater (stationary operation, ignition off)

With buttons C two different switch-on times can be selected within 24 hours.

■ Press and hold button. The appropriate figure 1 or 2 appears in display. The ready-for-action lamp lights up.

■ Set required switch-on time with buttons A. The display remains on for about 20 seconds after releasing button C.

In order to ensure that the heater starts up at the selected time, the lever for the heat output must be pushed fully over to the right. In addition to this the blower must be switched to stage 1. On account of the higher current consumption, a higher stage should only be selected in isolated cases.

### Switching preselected time off

■ The preselected time can be switched off by briefly pressing the appropriate button C. The ready-for-action lamp and the figure in display then go out.

### Fuses

See page 102.

### Notes

■ Every time the heater is switched off, the warm air and combustion air blowers continue running briefly to cool the heater down quicker.

■ To avoid draining the battery, do not run the heater repeatedly when the engine is not running.

When driving through mud and snow, the exhaust pipe may tend to get blocked. Have a look at it occasionally to see that it is clear.

### According to official German regulations:

The heat exchanger in the heater is only to be used for 10 years. After this period the heat exchanger must be replaced in a V.A.G workshop. The year in which the heater is first put into operation is marked on the nameplate on the heater.

The V.A.G workshop must then put the date of the repair on the plate on the heat exchanger.

■ In enclosed spaces and when filling the fuel tank, the heater must be switched off.

## OPERATION

### SLIDING ROOF\*



The roof is opened and closed with the crank above the driver's seat:

To **open** – Fold crank down and turn it to the left, then fold crank into recess again.

To **close** – Fold crank down and turn it to the right as far as it will go then turn it back until it can be folded into the recess.

#### Caution

**For safety reasons, the crank should always be in the recess.**

#### Note

If the roof becomes hard to operate after a while, the runners should be cleaned and greased – see page 94.

### SUN ROOF\*



The roof is opened and closed with the knurled disc in the headlining above the front seats.

The roof can be tilted at the rear as desired or taken out altogether.

#### Raising

Turn knurled disc clockwise.

#### Lowering

Turn knurled disc anti-clockwise.

#### To take out

- Turn retaining screw (A) in centre of knurled disc one quarter turn clockwise (e.g. with a coin) with roof closed.
- Then raise roof and press it up.
- Press locking lever (B) up.
- Detach roof.
- Lift roof from outside and pull it out to the rear.

#### To put back

- Slide roof back into the hinges and let it drop lightly into the retainers.

#### Caution

**Ensure that the roof is properly inserted into the two retaining hinges at the front, and locked at the rear.**

**The roof must only be unlocked when vehicle is stationary.**

## INTERIOR LIGHTS

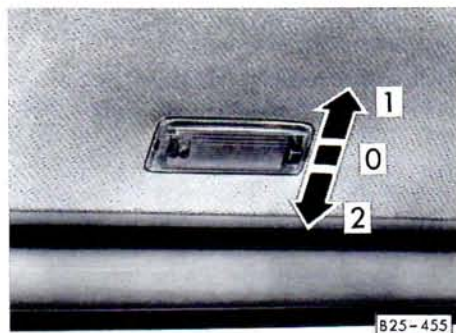

B25-455

**Light above driver's seat**

Switch positions:

- 1 – Light on continuously
- 0 – Off
- 2 – Door contact position, light comes on when cab doors are open.

**Step light\***

The step light comes on when sliding door is opened. It goes out a few seconds after the sliding door has been closed.

**Table light\***

Switch positions:

- To front – On
- To rear – Off



B25-375

**Reading lamps\***

The reading lamps have separate switches and can be moved about as required.

Switch positions:

- Ring turned to right – On
- Ring turned to left – Off

The reading lamp on the right at the rear lights up continuously when the sliding door is opened. When the sliding door is closed it goes out in the off position together with the step light after a delay of a few seconds.



B25-376

**Reading light in front of passenger seat\***

Switch positions:

- Up – Off
- Down – On

**Luggage compartment lights\***

The luggage compartment lights come on when the rear flap is opened.

**Note**

When leaving the vehicle ensure that all lights are switched off so that the battery is not run down if the vehicle is left stationary for some time.

## OPERATION

### SUN VISORS



Both sun visors can be lifted out of their brackets and swung round towards the doors.

An illuminated make-up mirror\* is fitted at the back of the passenger's sun visor.

To switch light on – move switch to left.

When the sun visor is moved up, the mirror illumination goes out automatically.

#### Note

When leaving the vehicle always ensure that the light is switched off so that the battery is not run down when vehicle is left standing for some time.

### ASHTRAYS

#### Ashtray in dash

To take out:

Grip the strip on opened lid and lift at one side to take out.

To insert:

Press ashtray into opening with lid closed.

#### Ashtray in passenger compartment

To take out:

Open ashtray, press down and take out.

To insert:

Insert at top first then push in fully.

#### On vehicles with individual seats:

To take ashtray out:

Lift one side of the handle of the opened lid.

To insert ashtray:

Push ashtray into opening with lid closed.

### CIGARETTE LIGHTER/SOCKET\*

The **cigarette lighter** is switched on by pushing in the element.

When the heating element glows, the lighter springs out automatically – pull it out immediately.

The **socket** can be used for a cigarette lighter or other electrical accessories with a capacity of up to 100 watts. When the engine is not running this will however soon discharge the battery.

#### Caution

**Cigarette lighter and socket also work when the ignition key has been taken out.**

**Children should therefore never be left alone in the car.**



## GLOVE BOX

Vehicles with a lockable glove box have an additional key – see also page 7.

To open the lid, squeeze both buttons together.

### Caution

For safety reasons the lid\* should always be closed when the vehicle is in motion.

## CURTAINS\*



The curtains which can be supplied for vehicles with seats/reclining seat bench are stored underneath the rear seat bench. They are secured to the window surrounds by press studs. A further curtain can be press-studded in position behind the front seats.

## EXTENDING TABLE\*

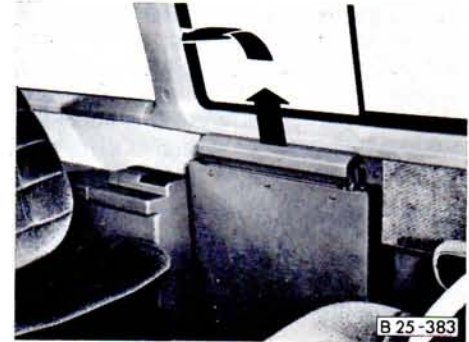

On vehicles with individual seats in the passenger compartment there is an extending table on the left side.

The table can be pulled up out of its retainers and folded down (see illustration).

### Caution

For safety reasons the table must be pushed in when vehicle is in motion.

## THE FIRST 1500 KM – AND AFTERWARDS

During the first few operating hours the engine internal friction is higher than later on when all the moving parts have bedded down. How well this running in process is done depends to a considerable extent on the way the vehicle is driven during the first 1500 km.

### Up to 1000 km do not use full throttle at all.

Furthermore the following speeds in km/h should not be exceeded in the gears:

#### Petrol engines

Manual gearbox	0–1000 km	
	4 speed gearbox	5 speed gearbox
1st gear	20	20
2nd gear	40	40
3rd gear	70	60
4th gear	105	85
5th gear	–	105

Automatic gearbox	0–1000 km
Driving range 1	35
Driving range 2	75
Driving range D	110

#### Diesel engines

	0–1000 km	
	4 speed gearbox	5 speed gearbox
1st gear	20	20
2nd gear	40	35
3rd gear	65	55
4th gear	95	85
5th gear	–	95

The **maximum** permissible engine speed during the first 1000 km is 4000 rpm.

The speeds given here must however not be exceeded.

#### From 1000–1500 km

the speed can gradually be increased to the road or engine maximum.

#### After the running-in period

on vehicles with a rev counter one should change into the next higher gear at the latest by the time the red warning zone is reached.

The maximum permissible engine speeds for continuous operation are:

Petrol engines . . . . . about 5400 rpm  
 Diesel engines . . . . . about 4600 rpm  
 Turbo Diesel engines . . . about 4800 rpm

In isolated cases, for example when overtaking the needle may move briefly into the dotted or shaded zone on the rev counter scale – see also page 37.

A speed limiter prevents extremely high engine speeds.

#### Important notes

■ Do not overrev the engine when cold – either in neutral or in the gears. All speeds and revs are only valid when engine is properly warm.

■ Do not drive with the engine speed unnecessarily high – changing up early helps to save fuel and reduces noise.

■ Do not let engine labour – change down when engine no longer runs smoothly.

■ New tyres must also be “run in” because they do not have maximum adhesion at the start. This must be taken into account by driving carefully during the first 100 km.

## DRIVING SAFELY

The **operational condition** of your vehicle is essential to safe driving.

So before moving off, always check the following points:

- **Lights and turn signals**
- **Brakes**
- **Amount of fuel**
- **Mirror settings**
- **Cleanliness of headlights, lenses and windows**

Also check at regular intervals:

- **Tyre condition and pressures** – page 86–89, 126.

- **Engine oil level** – page 74

The **oil level should be checked every time fuel tank is filled, or in difficult conditions or full throttle operation, daily**

- **Coolant level** – page 77
- **Brake fluid level** – page 82
- **Fluid level in windscreen washer** – page 80

- **Condition of windscreen wiper blades** – page 109.

Furthermore compliance with the specified Inspection intervals – in particular the brake fluid changing – is of great importance for driving safety – pages 82, 97.

**Safety on the road** depends to a large extent on the personal attitude and style of driving.

To be on the safe side you should:

- **Always put seat belt on before moving off – even in town traffic** – page 13.

In many countries the wearing of seat belts is compulsory anyway.

- **Ensure that all your passengers – including those on the rear seat – are wearing their belts** – page 13.

Passengers without seat belts can endanger not only themselves, but also the driver.

- **Adjust head restraints to body size.**

The upper edge of head restraint must be approximately at eye level.

- **Ensure that no articles interfere with operation of pedals** – page 89.

- **Stow all luggage correctly in boot – page 22**

**on the roof rack** – page 22

- **Do not drive when you feel tired.**

Stop for a break at the latest after driving for two hours.

- **Never drive when your reactions are impaired in any way.**

Not only alcohol but also drugs and many medicines can be very detrimental to your reactions.

- **Adapt vehicle speed to traffic and road conditions.**

Remember that particularly on smooth slippery roads the handling and braking – also on vehicles with four-wheel drive – is limited by the adhesion of the tyres. On wet roads the front wheels can aquaplane at high speeds. The vehicle can then no longer be steered properly.

Further instructions on safety are given in the various chapters in this manual.

### DRIVING ECONOMICALLY AND ENVIRONMENT-CONSCIOUS

The economy and the exhaust emissions and noise depend to a great extent on the **personal style of driving**.

To use as little fuel as possible and disturb the environment as little as possible and keep wear of engine, brakes and tyres to the minimum, the following points should be noted:

■ **Do not run engine to warm it up with the vehicle stationary.**

Drive off immediately after starting. Do not overrev.

■ **Avoid full throttle acceleration.**

■ **Avoid high engine speeds**

The best consumption and least disturbance of environment is obtained at low engine speeds in the highest possible gear. Drive as often and as long as possible in the highest gear.

The fuel consumption is for example twice as high in 2nd gear and 1.5 times as high in 3rd gear as in 4th gear.

■ **Change down only when engine no longer runs smoothly.**

Depending on gearbox you can normally drive on the level in the highest gear at 40–60 km/h and still accelerate.

■ **Avoid driving continuously at top speed.**

■ **Drive as smoothly as possible and look well ahead.**

Unnecessary acceleration and braking must be paid for with higher fuel consumption and more disturbance of the environment.

■ **Stop engine during traffic hold-ups.**

**The individual operating conditions** naturally also affect fuel consumption.

The following factors for instance are not favourable to fuel consumption:

■ Traffic density, particularly large towns with numerous traffic lights.

■ Frequent stop/start driving, particularly driving from house to house so that engine is never properly warm.

■ Driving in heavy, slow-moving traffic in low gear so that the engine speed is relatively high in relation to the distance covered.

One should, therefore, plan trips in advance to avoid unfavourable operating conditions.

Obviously the fuel consumption is also affected by factors over which the driver has no influence. It is for example normal for the consumption to increase in the winter or in arduous conditions (bad roads, trailer towing etc.).

### DRIVING ECONOMICALLY AND ENVIRONMENT-CONSCIOUS

The economy and the exhaust emissions and noise depend to a great extent on **the personal style of driving.**

To use as little fuel as possible and disturb the environment as little as possible and keep wear of engine, brakes and tyres to the minimum, the following points should be noted:

■ **Do not run engine to warm it up with the vehicle stationary.**

Drive off immediately after starting. Do not overrev.

■ **Avoid full throttle acceleration.**

■ **Avoid high engine speeds**

The best consumption and least disturbance of environment is obtained at low engine speeds in the highest possible gear. Drive as often and as long as possible in the highest gear.

The fuel consumption is for example twice as high in 2nd gear and 1.5 times as high in 3rd gear as in 4th gear.

■ **Change down only when engine no longer runs smoothly.**

Depending on gearbox you can normally drive on the level in the highest gear at 40–60 km/h and still accelerate.

■ **Avoid driving continuously at top speed.**

■ **Drive as smoothly as possible and look well ahead.**

Unnecessary acceleration and braking must be paid for with higher fuel consumption and more disturbance of the environment.

■ **Stop engine during traffic hold-ups.**

**The individual operating conditions** naturally also affect fuel consumption.

The following factors for instance are not favourable to fuel consumption:

■ Traffic density, particularly large towns with numerous traffic lights.

■ Frequent stop/start driving, particularly driving from house to house so that engine is never properly warm.

■ Driving in heavy, slow-moving traffic in low gear so that the engine speed is relatively high in relation to the distance covered.

One should, therefore, plan trips in advance to avoid unfavourable operating conditions.

Obviously the fuel consumption is also affected by factors over which the driver has no influence. It is for example normal for the consumption to increase in the winter or in arduous conditions (bad roads, trailer towing etc.).

### TRAILER TOWING

The vehicle is intended mainly for the transportation of persons, luggage and other loads but it can also be used to tow a trailer.

Trailer towing not only places more stress on the vehicle, it also calls for more concentration from the driver.

The vehicle must be specially equipped for trailer towing. In addition the operating and driving instructions on the next pages must be noted.

#### Technical requirements

If the vehicle is supplied with a factory-fitted towing bracket, all that is technically and legally necessary for trailer towing will have been taken into account. If electricity is required for additional items in the trailer (e.g. caravan refrigerator and interior lighting), the terminal 54g in the trailer socket must be subsequently connected.

If the vehicle is to be subsequently fitted with a towing bracket, the following must be noted:

- The towing bracket is a safety part. Only a bracket which has been designed and type-approved for this vehicle may be used. It is advisable to use towing brackets from the V.A.G range of accessories as these are identical to the ones fitted by the factory. The fitting instructions supplied with these brackets have been approved by the factory.

- In Germany the maximum draw bar weight must be shown on a clearly visible sticker at the rear of the towing vehicle.

- The trailer socket must be connected properly to the electrical system of the vehicle. This applies, where necessary to the terminal 54g in the socket.

- A special warning lamp must be fitted within the driver's range of vision to show that the trailer turn signals are working.

- As the factory installation of a towing bracket includes the modification of the cooling system, this should also be done when service installing a bracket. Otherwise overheating may occur when engine is pulling hard (mountains, high ambient temperatures, heavy trailer loads).

- V.A.G Dealers have all the necessary information about the installation of towing brackets and the fitting of a heavy-duty cooling system. The installation should therefore be done by them.

- In Germany the fitting of a towing bracket must be entered in the vehicle documents.

### Operating instructions

■ If the traffic behind the trailer cannot be seen properly with the standard rear view mirrors, additional outside mirrors will be necessary. Both outside mirrors must be fitted on folding arms and adjusted to give a good view to the rear at all times.

■ Pitching movements between towing vehicle and trailer can be reduced by heavy-duty springs and shock absorbers on the rear axle. If these springs and shock absorbers have not already been fitted at the factory, they can, in many cases, be service-installed by a V.A.G Dealer.

■ Pitching and snaking movements can also be reduced by stabilizers which can be obtained from and fitted by V.A.G Dealers in most European countries.

■ The permissible trailer weight – see page 130 – must not be exceeded on any account.

■ When towing a trailer in mountainous regions, note that the trailer weights given in the "Technical data" are only valid for gradients up to 10 or 12%. If the trailer weight is below the permissible maximum a correspondingly steeper gradient can be climbed.

■ The given trailer weights are only applicable for altitudes up to 1000 m above sea level. As the engine output and thus the climbing ability drops due to the decreasing air density above 1000 m the weight of vehicle and trailer must also be reduced by 10% for each further 1000 m or part thereof.

■ Where possible make full use of the maximum permissible drawbar weight on ball of the towing bracket – see page 130 – but do not exceed it.

■ While observing the permissible trailer and drawbar weight, distribute the load in the trailer so that heavy objects are as near as possible to the axle. The objects must also be secured so that they cannot slip about.

■ The trailer and drawbar load figures on the data plate of the towing bracket are for test certification only. The correct figures for the vehicle, which are lower than the above figures, are given in the vehicle documents and in this manual.

■ The towing bracket increases the unladen weight of the towing vehicle and the payload must be reduced to correspond.

■ Check the tyre pressures on the towing vehicle and on the trailer.

■ The headlight settings must be checked with trailer attached before moving off and altered as necessary.

### Driving Tips

To obtain the best possible handling of vehicle and trailer, the following should be noted:

- Try to avoid driving with an unladen vehicle and a loaded trailer. If this cannot be avoided, only drive slowly to allow for the unfavourable weight distribution.

- The regulations regarding trailer weights and speeds when towing which are valid in various countries must always be observed. In Germany for example the permissible speed when towing a trailer is 80 km/h.

For safety reasons do not drive faster even in countries where the permissible speed is higher.

Furthermore, if the vehicle is registered as a commercial vehicle there may be restrictions on driving and trailer towing on Sundays and public holidays.

- As driving stability of vehicle and trailer decreases when the speed increases do not drive at the maximum permissible top speed in unfavourable road, weather and wind conditions – particularly when going downhill.

In any case the speed must be reduced immediately the trailer shows the slightest sign of snaking. On no account try to stop the snaking by accelerating.

- Always try to brake in good time. If the trailer has an overrun brake apply brakes gently at first then brake firmly. This will avoid the jerking caused by the locking of the trailer wheels. Change down before going down a steep hill so that the engine can act as a brake.

- The cooling effect of the radiator fan cannot be increased by changing down because the speed of the fan is not dependent on the engine speed. One should therefore not change down even when towing a trailer as long as the engine can cope without vehicle speed dropping too much.

### Notes

- During the running-in period avoid trailer towing as far as possible.

- It is advisable to have the vehicle serviced between the Inspection intervals if it is used frequently for towing a trailer.



## DRIVING A FOUR-WHEEL DRIVE VEHICLE\*

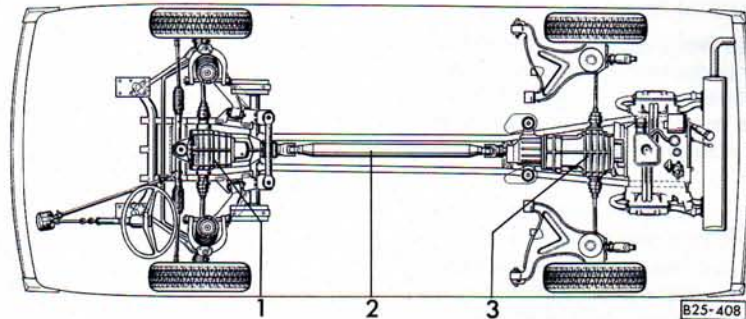
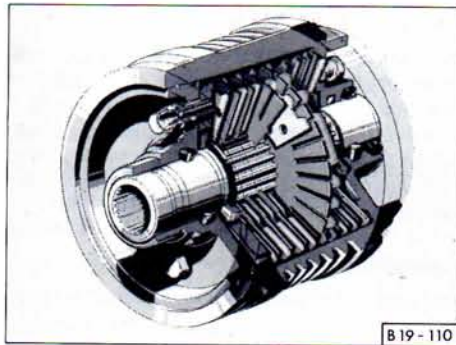

1 – Front axle final drive  
and viscous coupling

2 – Propshaft

3 – Rear axle final drive

### The drive concept

Contrary to the normal type of selectable four-wheel drive, the four-wheel drive on the Transporter/Caravelle syncro is always in action. Only the amount of power being transmitted to the front and rear wheels changes according to the requirements. This automatic distribution of the driving forces is attained through a wear resistant viscous coupling incorporated in the front axle. This ensures, on the one hand, that the driving force losses are kept as low as possible, and on the other hand, that the best possible traction is attained when required.

This ingenious drive concept make the Volkswagen Transporter/Caravelle syncro a versatile, efficient road vehicle which proves itself on ice and snow and in off-road conditions.

### Advantages of four-wheel drive

The special drive concept of the Volkswagen Transporter/Caravelle syncro, when compared with a vehicle which only has a two-wheel drive, has advantages in respect of the following points:

#### The traction

The traction is increased considerably by the permanently engaged four-wheel drive. This is of particular benefit on snow and ice, when moving off and when driving on difficult mountain roads.

Driving in such conditions is less hazardous with the Volkswagen Transporter/Caravelle syncro:

There is no longer any need to drive past obstacles at speeds on slippery uphill stretches, because one is afraid of becoming stuck, one can approach slowly, stop and then start off again.

#### The acceleration

As the driving force to be put onto the road goes to four wheels instead of two, the amount of slip is considerably reduced. This improves the adhesion between tyre and road surface and thereby, the acceleration capabilities on slippery road surfaces.

#### The handling

Decisive for the handling – particularly on slippery roads – is the grip between the four wheels and the road surface.

On two-wheel drive vehicles the driving wheels can spin on slippery surfaces if too much acceleration is given. This is detrimental to the adhesion.

By distributing the driving forces to four wheels instead of two the lateral forces which can be transmitted are increased on the Volkswagen Transporter/Caravelle syncro. The vehicle is less likely to break away.

#### Using winter tyres

With the four-wheel drive the Volkswagen Transporter/Caravelle syncro has good traction in winter road conditions even with the standard tyres. However the use of winter or all-weather tyres is recommended on all four wheels to obtain even better handling and braking.

For cross country driving the traction can be improved considerably with winter tyres.

#### Using snow chains

Snow chains improve not only the traction in winter road conditions but also braking. For this reason snow chains must also be used on vehicles with four wheel drive when snow chains are obligatory. Further details about using snow chains are given on page 89.

#### Operation

Contrary to customary four-wheel drives, the driver of a Volkswagen Transporter/Caravelle syncro does not need to engage or disengage the drive. The distribution of the driving force to the front and rear axles takes place automatically, and always matched to the existing road surface conditions.

Incorrect operation is thus excluded and the driver can concentrate fully on the traffic.

Only the differential locks\* have to be engaged by hand in special operating conditions. Further details are given on the next two pages.

### Driving on dry roads

The **differential locks must not be engaged**. They do not provide any advantages at all on dry road surfaces, but impair the vehicle's steerability.

**Particularly if the front axle differential lock is engaged, the vehicle is no longer steerable.**

Important instructions on the differential locks are to be found on page 27.

### Driving on wet, slippery roads

Due to the four-wheel drive, the engine power is transferred even to a relatively smooth road surface.

#### On wet surfaces

On wet roads one should also note that even with the Transporter/Caravelle syncro it is possible for the front wheels to aquaplane at high speeds.

**For this reason, one should avoid excessive speed and drive at a speed compatible to the road conditions.** The **differential locks\*** must **not** be engaged.

Important instructions on the differential locks are to be found on page 27.

#### On slippery surfaces

On slippery surfaces the rear axle differential lock may only be engaged when moving off, and at very low speed. The lock should then be disengaged again.

**The front axle differential lock must not be engaged.**

Important instructions on the differential locks are to be found on page 27.

### Notes

**The style of driving must always be adapted to suit the road surface and traffic conditions. The increased safety offered by this type of vehicle must not encourage one to take unnecessary risks.**

**In particular, one must always remember that the stopping ability is limited by the adhesion of the tyres on the road surface. The braking capability of the vehicle is the same as that of a normal two wheel drive vehicle. For this reason, one should never be tempted by the good acceleration capabilities, even on slippery road surfaces, into driving too fast.**

### Driving cross country

Before driving for the first time over difficult terrain, it is advisable to make yourself familiar with the vehicle on normal roads, and also under easier off-road conditions. For safe driving cross country, the following rules are of great importance.

- Always wear your seat belt.
- Timely gear changing is better for the engine and prevents the vehicle from bogging down.
- Never drive with the clutch slipping as this leads to premature wear.
- The more uneven and creviced the terrain, the lower the speed must be. Pay attention to the vehicle's ground clearance.
- Do not drive over small embankments or declines at excessive speed. This can lead to bouncing during which it would be impossible to avoid any obstacle which may suddenly appear. In addition it could lead to vehicle damage.
- Drive down gradients in the same gear as you would drive up.

■ Embankments, gradients and similar obstacles should only be driven up or down at right angles, i.e. directly in line with the slope.

■ If however one is forced to drive across a slope and the vehicle tends to tip, one should immediately steer directly into the slope.

■ Before driving through water, determine the depth – the **permissible wading depth** (see Technical Data) **must not be exceeded**.

■ **After driving through water or mud** the following points are important:

- Disengage differential locks\*
- Clean excess dirt from engine compartment and underside of vehicle so that all moving and electrical and/or electronic parts can function properly.
- Clean tyres and wheels roughly and examine tyres for foreign bodies in the treads and damage.
- Clean turn signals, lights and the number plate.
- Dry the brakes by driving a short distance with the brake pedal depressed. This will prevent brakes from pulling to one side or braking effect being retarded.

– After going through **deep water**, pull dipstick out and check if there are drops of water on it or if the oil level has risen. If this is the case the oil must be changed without delay.

■ **After driving through mud** the brakes must be checked and if dirty, cleaned. This will prevent damage and premature wear to the brake system.

■ If, during **cross country** driving the vehicle sank deeply into soft ground or bottomed on an obstacle, the running gear, brake hoses and engine sump must be checked for damage.

### Note

To prevent damage to the underside of the vehicle, the vehicle is equipped with protective plates in front of the front axle and underneath the engine and gearbox and protective rails running along both sides of the propshaft.

### Note for vehicles with differential lock(s)

Before driving through a difficult cross country stretch (e.g. mud, sand, water, snow or steep gradients) it is advisable to engage the differential lock(s)\* at low speed. **Important instructions regarding the differential locks are to be found on pages 26 and 27.**



To prevent the engine from drawing in water through the intake air preheater and being damaged when wading, there is a valve in the engine compartment on the right behind the maintenance flap with which the intake air preheating can be closed. The valve is closed by pressing it down and turning it to the right.

### Output testing

If the Transporter/Caravelle is to be output tested on a dynamometer, the propshaft must be removed.

### Brake test stand

For brake testing e.g. at MOT, the propshaft must be removed. The differential locks must not be engaged.

# OPERATING INSTRUCTIONS

## FUEL

### Petrol engines

Vehicles with catalytic converter 70 kW fuel injection engines

**Lead-free regular petrol RON<sup>1)</sup> not lower than 91.**

If regular petrol with adequate anti-knock properties is not available, use premium petrol (lead-free or leaded) or a suitable mixture.

### For all vehicles with catalytic converter

**Only lead-free petrol may be used in these vehicles.**

The use of leaded petrol is very detrimental to the functioning of the emission control system because the lead is deposited in the catalytic converter.

**Even one tankful of leaded petrol will detract from the efficiency of the catalytic converter.** Although lead-free fuel may again be used afterwards the original efficiency of the catalytic converter is never fully attained.

On vehicles with Lambda probe<sup>2)</sup> the mixture formation is also negatively affected.

**Vehicles without catalytic converter 44 and 57 kW carburetor engines**

**Lead-free or leaded regular petrol RON<sup>1)</sup> not lower than 91.**

**In the interests of our environment lead-free petrol should be used whenever possible.**

If regular petrol with adequate anti-knock properties is not available, use premium petrol (lead-free or leaded) or a suitable mixture.

**82 kW fuel injection engine.**

**Leaded premium petrol RON<sup>1)</sup> not lower than 98.**

### Note

Lead-free petrol must comply with DIN<sup>3)</sup> 51607 and leaded petrol with DIN 51600.

<sup>1)</sup> Research Octane Number, indicates anti-knock properties of the petrol.

<sup>2)</sup> Lambda = Air/petrol relationship.

<sup>3)</sup> Standards issued by the German Standards Institution.

## Petrol additives

On carburetor engines with and without catalytic converters carburetor icing can occur at ambient temperatures between 0° C and +15° C when the air humidity is high despite the automatically controlled intake air preheating. This can cause the engines to stall occasionally when idling in the warm-up phase.

Even the anti-icing additives contained in some fuels in the cold season cannot entirely prevent carburetor icing. When a properly tuned engine stalls repeatedly in the conditions described above it is advisable to mix **Volkswagen petrol additive** with the fuel. This additive prevents carburetor icing and also cleans the carburetor and protects it against corrosion. It is obtainable from V.A.G workshops in Germany and in many export countries.

No other fuel additives should be mixed with the petrol.

## Diesel engines

**Diesel fuel to DIN 51601 CN') not lower than 45**

### Driving in winter

When using summer Diesel trouble may be experienced at temperatures below 0° C because the fuel thickens due to wax separation.

For this reason, winter Diesel which is more resistant to cold is sold during the winter and works satisfactorily down to about -15° C.

In countries with different climatic conditions the Diesel fuels offered have a different temperature behaviour. Check with V.A.G dealers or filling stations in the country concerned regarding the availability of Diesel fuels.

When necessary summer and winter Diesel can be used at lower temperatures by mixing regular leaded or lead-free petrol (not premium) with the Diesel.

As this additive reduces the engine output, only the amount actually required should be used: **(max. 30%)**

Temperature in ° C	Summer Diesel	Petrol	Winter-Diesel	Petrol
- 0 to - 5	85%	15%	100%	-
- 5 to -15	70%	30%	100%	-
-15 to -25	-	-	70%	30%

This table is based on the fuels available in Germany.

**Due to the inflammability of petrol the mixing should, for safety reasons, only be done in the vehicle tank. Where possible, the petrol should be put into the tank before the Diesel.**

Mixing must take place before the wax starts to separate because subsequent mixing is effective only in the tank but not in the rest of the fuel system.

## FILLING TANK



### Filter preheating\*

If the vehicle is fitted with a filter preheater, the fuel system will be kept operational down to  $-25^{\circ}\text{C}$  if winter Diesel fuel is used. One can recognise the preheated filter by the additional valve and hose connections (see Fig.).

Dilution with petrol is then no longer necessary.

### Generally applicable:

It at temperatures below  $-25^{\circ}\text{C}$  the fuel has already waxed to such an extent that the engine will not start it is sufficient to place the vehicle in a warm room for a while.

Fuel additives (anti-waxing agents and similar) **must not** be used with the Diesel fuel.

The filler neck is on the right hand side of the vehicle.

Key A = see page 4 – fits the lockable tank cap\* (on vehicles with four wheel drive an extra key is supplied).

The fuel tank capacity is approx. 60 litres (Syncro 70).

Trouble-free refueling calls for correct use of filler nozzle.

■ Insert nozzle fully into tank neck and do not tilt it.

On vehicles with a factory fitted catalyst it should be noted that the filler neck is smaller in diameter and is closed with a spring-loaded flap below the filler opening. Filler nozzles for lead-free petrol are correspondingly smaller in diameter and open the flap when inserted into the filler neck. This is to ensure that only lead-free petrol can be put in the tank.

■ Do not try to fill tank too quickly, otherwise the fuel (especially Diesel) will foam and this may cause nozzle to switch off too soon.

As soon as the correctly operated automatic nozzle switches off for the first time, the tank is full. Do not try then to put more fuel in because otherwise the expansion space in tank will be filled – the fuel can then overflow when it gets warm.

### Note for vehicles with Diesel engine: Bleeding the fuel system

The fuel system does not need bleeding when tank has been run dry – this takes place automatically while starting.



**What to do when wrong fuel has been put into tank.****Premium petrol instead of regular**

The engine can be run on premium fuel with no problems. A worthwhile reduction of fuel consumption or increase in output should however not be expected.

**Regular petrol instead of premium.**

In isolated cases the engine can also be run on regular petrol but the octane rating must not be under 91 RON. The vehicle must then only be driven at medium engine speeds and low engine loading. High engine loading with full throttle or high engine revs can cause engine damage. Fill tank with 98 RON premium petrol as soon as possible.

**Lead-free premium petrol with 95 RON instead of leaded premium petrol**

The engine can also be run as an exception on this fuel. However the style of driving must adapted to the lower antiknock properties of this petrol – see previous paragraph.

**Leaded petrol instead of lead-free**

Vehicles with catalyst must not be driven on leaded petrol because otherwise the function of the emission control system is affected considerably – see also page 67. The fuel system must be emptied, in accordance with environmental regulations – preferably by a V.A.G workshop.

**Petrol instead of diesel**

The engine can be run on a concentration of up to approx. 30% leaded or lead-free regular petrol (not premium). However if premium petrol or a large quantity of regular petrol has been put in the tank accidentally, the engine must not be run otherwise damage will occur. The fuel system must be emptied bearing in mind environmental control regulations – preferably by a V.A.G workshop.

**Diesel instead of petrol**

The engine may not be run on Diesel. The fuel system must be emptied bearing in mind the environmental control regulations – preferably by a V.A.G workshop.

## LUBRICANTS

### Petrol engines

A special very high quality oil is put in the engine at the factory and this can be used all the year round – except in very cold climates.

As a high quality engine oil is a prerequisite for trouble free operation and long engine service life only a correspondingly high quality oil may be used for topping up and at oil changes.

As it has been established that the wide range of oils on sale differ considerably in quality, we strongly recommend that only the following mineral and synthetic oils, which have been tested by us, are used:

- Multigrade oils, specification VW 50101 or
- Improved lubricity oils, specification VW 50000 or
- High performance engine oils, specification VW 50000 and 50500.

The specifications must be marked on the container. When topping-up the oils can be mixed with one another.

Multigrade oils to VW Standard 50101 are reasonably priced oils with the following properties:

- All year round use in temperate climate areas.
- Excellent cleaning ability.
- Efficient lubrication at all engine temperatures and load conditions.
- High resistance to ageing.

The improved lubricity and high performance engine oils have in addition the following advantages:

- All year round use at practically all temperatures.
- Low frictional losses in engine.
- Best possible starting even at very low temperatures.

Only if at some time the approved oils are not available can a good quality oil with the specification API-SF (multigrade or single grade) be used as a temporary exception.

V.A.G Dealers have all the details. The oil change should therefore preferably be done by a V.A.G Dealer.

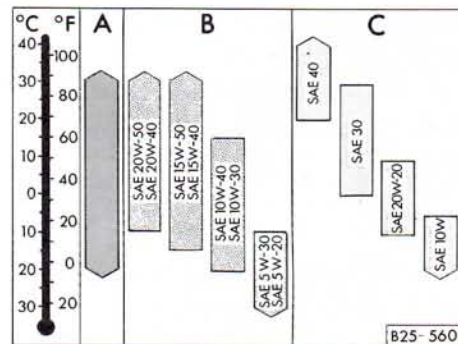

A – High performance and improved lubricity oils, B – Multigrade oils, C – Single grade oils.

The viscosity class of the oil must be selected as shown in the Fig. The oil does not have to be changed when the ambient temperature is briefly above the range shown.

When using SAE 10 W single grade oil or SAE 5 W-20 or SAE 5 W-30 multi-grade oils, continuous high engine speeds and engine loading should be avoided.

This restriction does not apply when using high performance or improved lubricity oils.

## Diesel engines

A special very high quality oil is put in the engine at the factory and this can be used all the year round – except in very cold climates.

For topping up and changing, the following mineral or synthetic oils are to be used:

- Good quality oils, specification API-CD (only for topping up on the Turbo Diesel engines in an emergency) or
- Multigrade oils, specification VW 50101 (not for Turbo Diesel engines) or
- Multigrade oils, specification VW 50500 or
- Improved lubricity oils, specification VW 50000 (not for Turbo Diesel engines) or
- High performance engine oils, specification VW 50000 and 50500.

The specifications must be marked on the container. When topping-up the oils can be mixed with one another.

The advantages of improved lubricity and high performance engine oils for petrol engines mentioned on the previous page also apply when these oils are used in Diesel engines.

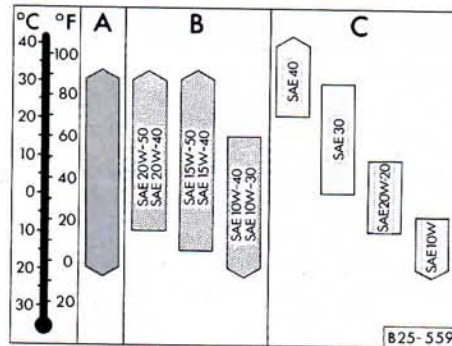

A – High performance and Improved lubricity oils, B – Multigrade oils, C – Single grade oils.

The **viscosity class** of the oil must be selected as shown in the Fig. The oil does not have to be changed when the ambient temperature is briefly above the range shown.

When using SAE 10 W single grade oil do not drive with high engine speeds and full throttle for long periods.

## Manual gearbox and final drive

- Gear oil, API-GL 4, SAE 80

## Front axle differential (syncro)

- Gear oil, API-GL 5, SAE 90

## Automatic gearbox

- Final drive: Gear oil, API-GL 5, SAE 90
- Gearbox part: ATF Dexron®

## Power assisted steering

- ATF Dexron®

## Lubricant additives

No additives should be mixed with the engine oil or the other lubricants.

No damage caused by the use of such additives will not be covered by the warranty.

## ENGINE OIL



### Checking oil level

Every engine uses a certain amount of oil. The **oil consumption** can be up to 1.5 litres per 1000 km.

The engine oil level must therefore be checked at regular intervals, preferably when filling the tank. **In arduous operating conditions or when engine is working hard it should be checked daily before moving off.**

The dipstick and filler pipe can be reached through a flap behind the rear number plate.

The dipstick location is shown in the illustration:

The vehicle must be on a level surface when checking oil level. After stopping engine wait a few minutes for the oil to drain back to the sump.

Then pull the dipstick out, wipe it with a clean cloth and insert again. Then pull dipstick out again and check the oil level:

The level must be between the two marks.

The difference in quantity between the min. and max. marks is 1.0 litre.

When the engine is working hard such as in sustained high-speed motorway cruising in summer, when towing a trailer or when climbing mountain passes, the oil level should be kept up to the max. mark.

### Topping up engine oil

Unscrew the cap from the oil filler and pull extension pipe out fully.

Add oil.

Push extension pipe in again and screw the cap back on tightly.

Check the level with the dipstick – the oil should not be above the max. mark.

### Changing engine oil

The engine oil deteriorates not only due to use when engine is running but also due to ageing. The engine oil changing times depend therefore on the mileage and also the time elapsed.

### Petrol engines

Engine oil change every 15000 km or every 12 months (whichever comes first).

### Diesel engines

Engine oil change every 7500 km or every 12 months (whichever comes first).

For further detail, see Service Schedule.

### For all engines

■ If the vehicle is used continuously in arduous conditions, the engine oil must be changed at shorter intervals – see also page 91.

■ Disposal of the old oil must be done in accordance with environmental protection regulations.

Recommended oils and viscosity classes – see page 72.

## GEARBOX OIL

### Checking oil level

With the manual gearbox and front axle differential (syncro) the oil level does not need checking.

With the automatic gearbox the oil level in the final drive also does not need checking.

The ATF level in gearbox part must however be checked in between the intervals given in service schedule.

To do this the vehicle must be standing on a level surface. The level must only be checked when the ATF is **warm** (about 10 km after starting from cold the ATF is at the correct temperature). If fluid is cold or too hot the reading will be incorrect. The engine must be running at idle speed, the handbrake must be applied and the selector lever at "P".

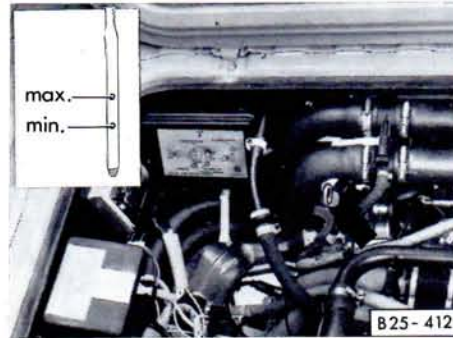

To check, pull dipstick (see Fig.) out, wipe with a clean lint-free rag and then insert it fully again.

Pull dipstick out and check ATF level. When the ATF is warm **the level must be between the two marks** – otherwise the vehicle must be taken to a V.A.G workshop without delay so that they can find the reason for the incorrect level. It is not sufficient to merely top up or drain off ATF.

### Changing oil

With the manual gearbox and front axle differential (syncro) the oil does not need changing.

With the automatic gearbox the oil in the final drive also does not need changing. The ATF in gearbox part must however be changed at the intervals given in service schedule. Due to the special tools required, the job knowledge necessary and the disposal problems, this should preferably be done by a V.A.G Dealer.

### Note

**When there is no lubricant in the manual or automatic gearbox the engine must not be started and the vehicle may only be towed with driving wheels lifted.**

# OPERATING INSTRUCTIONS

## POWER ASSISTED STEERING\*

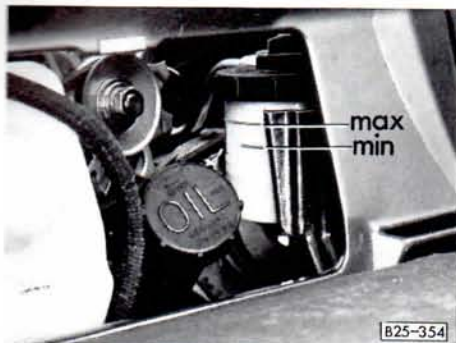

### Note

If the power assisted steering fails at any time or when engine is not running (vehicle on tow) the vehicle can still be steered but more force will be required to turn the steering wheel.

To ensure satisfactory operation of the system it is essential that the fluid level in reservoir is correct.

The reservoir is in the engine compartment on the right behind the maintenance flap.

The check must only be done with the engine running and the wheels in straight-ahead position.

The fluid should always be between the "max" and "min" marks. When level has dropped to min. mark, ATF (Dexron®) should be added after removing the red cap in top of reservoir.

## COOLING SYSTEM

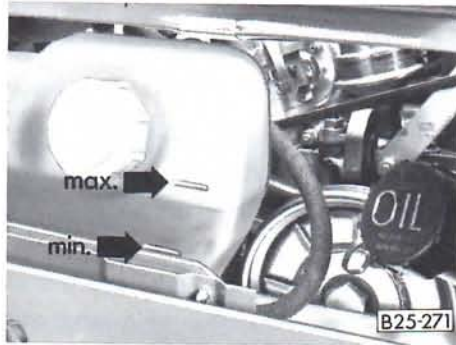

Reservoir

The cooling system is filled at the factory with a permanent coolant which is not changed. This coolant consists of water and our G11 additive (anti-freeze on Glycol basis with anti-corrosion additives). This mixture not only gives the necessary frost and corrosion protection but also prevents scaling and raises the boiling point of the coolant. Should it become necessary at anytime to add coolant or refill the system, only a mixture of pure water and G11 or a coolant

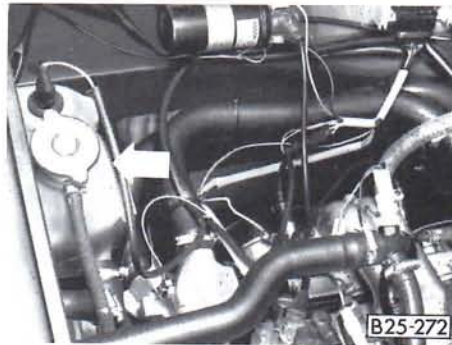

Expansion tank – Petrol engines

additive with the specification TL-VW 774 A (note marking on the container) is to be used – see also next page "Topping up coolant".

### Caution

**The coolant additive and the coolant are poisonous.**

The additive must therefore only be stored in the original container out of reach of children. If the coolant has to be drained at anytime, it must be caught and also stored in a safe place until it is reused.

If the coolant is not to be used again it must be disposed of in accordance with environmental protection regulations.



Expansion tank – Diesel engine

In the engine compartment there is a reservoir and an expansion tank.

The coolant level is normally only checked in the reservoir. It only needs checking in the expansion tank if a large amount of coolant has been lost or if the warning lamp for coolant temperature/coolant level lights up.

## Checking coolant level

The correct coolant level is essential to the satisfactory operation of cooling system.

Open flap behind number plate. The level should be between min. and max. marks when engine is cold or just above the max. mark when engine is warm.

**The level can only be checked properly when engine is not running.**

## Coolant losses

In normal conditions the cooling system is almost maintenance-free.

Coolant loss normally indicates leakage in the system. In this case the cooling system should be checked by a V.A.G workshop without delay. It is not sufficient to merely add coolant.

In a water-tight system losses can only occur if the boiling point of the coolant is exceeded as a result of overheating.

Overheating can occur if:

- the flow of cooling air is reduced, e.g. by a radiator muff, very dirty radiator fins (leaves, dust, insects) or additional driving lights in front of radiator grille
- the boiling point of the coolant has been lowered by an incorrect mixture – see next page "Topping up coolant".
- the radiator fan is not working – see next page "Fan", or

■ vehicle is driven up a long hill in too low a gear with engine speed very high and at very high ambient temperatures – see next page "Fan".

If the cause of the overheating cannot be found and eliminated, contact a V.A.G dealer as soon as possible as otherwise serious damage may be done to the engine.

## Topping up coolant

Topping up is normally done in the reservoir only.

**Do not fill above the max. mark.**

The excess coolant will be forced out of the system when engine gets hot.

**If the coolant warning lamp comes on** the expansion tank must also be checked and filled to brim if necessary.

First switch the engine off and let it cool down, then cover cap with a cloth and turn cap one quarter turn to the left and let pressure escape first. Then take cap off.

## Caution

**Do not remove cap when engine is hot.  
Danger of scalding.  
System is under pressure.**



In order to maintain the corrosion protection at all times and prevent the system from scaling up and the boiling point from being lowered the mixture should not be altered **even in the summer or in warm countries by adding plain water: the coolant additive proportion should be at least 40% (anti-freeze protection down to about -25° C).**

#### **Screw cap on again tightly.**

The system must then be bled with engine running (at a fast idle). Take air intake grille off (see page 104), open vent screw at top of radiator and set heater lever to "warm". As soon as coolant emerges, close vent screw. Top level up in reservoir and expansion tank.

#### **Fan**

The fan is driven electrically and controlled by a thermostich which is actuated by the coolant temperature.

When the engine is hot, the fan may continue to run when the engine has been stopped or it may switch on suddenly – even when ignition is off.

#### **Notes**

■ If the fan is not running although the coolant temperature is very high, the fuse should be checked and renewed if necessary – see page 103.

■ The speed of the fan does not depend on engine speed. The cooling effect cannot therefore be increased by changing down.

As long as the engine runs smoothly and a gradient can be taken without a large drop in speed it is not necessary to change down.

#### **Driving in winter**

The mixture put in the system by the factory provides frost protection down to about -25° C. To ensure that frost protection is adequate, the coolant should be checked before the cold season begins and if necessary, undiluted coolant additive G11 or an additive with the specification TL-VW 774 A added.

If greater protection against frost is required, the proportion of G 11 additive can be increased, but only up to 60% otherwise the anti-freeze protection is reduced and furthermore the cooling effect is impaired.

Vehicles for export to cold countries usually have frost protection down to -35° C.

## WINDSCREEN WASHER SYSTEM



The filler opening of the container is under the carpet on left hand side of front footwell. The container holds about 3.5 litres. On vehicles with a headlight washer the capacity is 6.5 litres.



On vehicles with rear window washer\* there is an additional container on the right in the luggage compartment. This container holds about 1 litre.

### To fill container

Lift carpet, open flap and unscrew cap. Fill container to top with water and screw cap on again. Switch ignition on and check that washer is working.

It is advisable to add a window cleaner solution (with anti-freeze additive in winter) to the water because plain water is not usually sufficient to clean the glass and headlight lenses quickly and thoroughly.



### Adjusting washer jets

When vehicle is stationary, the water should hit the windscreen at the following points:

a = 490 mm      c = 180 mm  
b = 220 mm      d = 350 mm

The water jet for the rear window should hit the window in the centre of the wiped area.

The jets can be adjusted with a needle.

The jets for the headlight washer system\* can only be adjusted with a special tool. When adjustment is necessary, contact your V.A.G workshop.

## BRAKE SYSTEM

The following points are of particular importance to the safe operation of the brakes.

■ New brake linings must also be run in and do not have the optimum friction properties during the first 200 km. The slightly reduced braking effect can be compensated for by slightly more pressure on the brake pedal. This also applies when new linings have been fitted.

■ On hills change down in good time to make use of the braking effect of engine. This relieves strain on the brake system. When brakes are applied do not keep them on continuously, apply and release alternately.

■ In certain operating conditions, for example after driving through water, after heavy rain or after washing the vehicle the braking effect may be retarded by wet, or in winter iced-up brake discs and linings – the brakes must be dried first by applying the footbrake.

The full braking force may also be retarded when vehicle has been driven for some time on heavily salted roads without using the brakes because the layer of salt on discs and pads has to be removed first.

Further details – particularly for vehicles with four wheel drive – are given on page 66.

■ Brake lining wear depends to a large extent on the operating conditions and style of driving. On vehicles which are used mainly in town traffic and stop/start conditions or are driven hard it may be necessary to have the thickness of the brake linings checked in a V.A.G workshop in between the intervals given in the service schedule.

■ If the brake pedal travel increases suddenly, it may be that one of the two brake circuits has failed. You can still drive on to the next V.A.G workshop but be prepared to use more pressure on the pedal and allow for longer braking distances on the way.

The failure of a brake circuit is shown by the lighting up of the brake warning lamp\* (see also page 36).

The brake fluid level must be checked regularly – see next page.

### Brake servo

The servo is operated by vacuum which is only available when engine is running.

#### Caution

**For this reason the vehicle should not be allowed to roll with engine not running.**

When the brake servo is not working because, for example, the vehicle is being towed or because a defect has occurred on the brake servo, the brake pedal must be pressed harder.

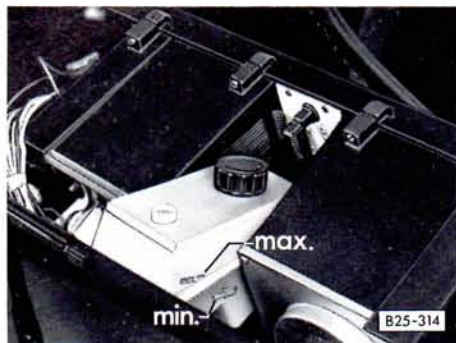

## Brake fluid reservoir

The fluid reservoir is in the dash under the dash cover panel. The panel can be lifted to fill the reservoir. To do this grip in the recess at the back of the cover. When installing insert the lower front edge first.

## Checking fluid level

The correct fluid level is essential to the satisfactory operation of the brake system. The fluid level must always be between the "max" and "min" marks.

The level of fluid tends to sink slightly when the vehicle is used due to the automatic adjustment of brake lining wear. This is quite normal.

However, if the level sinks noticeably in a short time or drops below the "min" mark the system may be leaking. Take the vehicle to a V.A.G workshop at once and have the brake system checked.

The failure of a brake circuit is shown by the lighting up of the brake warning lamp\* (see also page 36). When this happens take the vehicle to a V.A.G workshop immediately and have the brake system checked.

## Brake fluid

Brake fluid absorbs moisture. In the course of time it takes up water from the ambient air. Too high a content of water in the brake fluid can cause corrosion damage in the system in time. Furthermore the boiling point of the brake fluid is reduced considerably. This can then cause the formation of vapour bubbles in the fluid when the brakes are used hard. The efficiency of the brakes and thus the vehicle safety is then seriously affected.

**For this reason the brake fluid must be renewed every two years.**

Use only our genuine brake fluid (specification to US standards FMVSS 116 DOT 4). The fluid must be new.

## Caution

**Brake fluid is poisonous.**

**It must therefore only be stored in the closed original container out of reach of children.**

**Brake fluid will also damage paintwork and the plastic material of which the dash is made. Take great care not to spill any fluid when topping up the reservoir. Cover area round reservoir if necessary.**

**Environmental protection regulations must be observed when disposing of the fluid.**

V.A.G Dealers have all the necessary information and stock the specified brake fluid.

The renewal of the fluid should therefore be carried out by a V.A.G Dealer, preferably during an Inspection Service.

**ANTI-LOCKING BRAKE SYSTEM\***

The ABS plays a major part in increasing the active safety of the vehicle. The big advantage of the ABS compared with the conventional brake system is that even when braking on slippery surfaces the wheels do not lock. The vehicle remains steerable and the best possible driving stability is retained.

When the turning speed of a wheel reaches a level which is too low for the vehicle speed and it tends to lock, the brake pressure to this wheel is reduced. This regulating process is felt as a pulsation of the brake pedal and is accompanied by noises. This is deliberately done as a warning to the driver that the wheels are in the locking range. **The speed must immediately be adapted to the road and traffic conditions.**

**Particularly on slippery roads the ABS cannot overcome the physical limits. The increased amount of safety available must not tempt one into taking any risks when driving.**

Every time the engine is started the ABS is switched on automatically. The functioning of the ABS is indicated by a warning lamp – see page 36.

**PEDALS**

The movement of the pedals must not be restricted.

For this reason, do not put articles in the footwell which could roll or slide underneath the pedals.

Around the pedal area there should also be no foot mats or other additional floor covering materials:

- In the case of defects on the brake system, a greater pedal travel may be necessary.
- It should always be possible to depress the clutch and accelerator pedals fully.
- All pedals must be able to return, unhindered, to their rest positions.

For these reasons therefore, the only foot mats which may be used, are those which leave the pedal area completely free and which are prevented from slipping.

## BATTERY

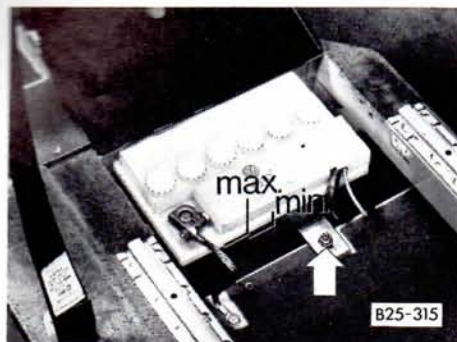

On vehicles with a petrol engine the battery is under the right hand seat. It can be reached when seat is pushed fully forward.

On vehicles with a Diesel engine the battery is on the right hand side of the engine compartment.

On vehicles with swivelling seats the seat must be turned 180° and pushed fully forward.

### 2nd Battery\*

The 2nd battery is under the left hand seat. Access is gained by sliding the seat forwards as far as possible.

On vehicles equipped with ABS the 2nd battery is at the rear left hand side, inside the vehicle.

The 2nd battery supplies power for additional fitments when the vehicle and engine are stationary. A cut-off relay between the 1st and 2nd batteries prevents the 1st battery from being run down as well. This ensures that there is always sufficient power available for starting. When the vehicle is on the move, the 2nd battery is charged up together with the 1st one.

### Checking acid level

In normal operating conditions the battery requires hardly any maintenance. At high ambient temperatures however it is advisable to check the acid level at regular intervals. It should always be between the min. and max. marks on the side of the battery.

### Caution

**Battery acid is corrosive and must not get into the eyes or on to skin and clothes.**

**Any acid splashes must be washed off thoroughly with water. See a doctor if necessary.**

**The level should therefore preferably be topped up in a V.A.G workshop.**

## Winter driving

Winter weather is particularly hard on the battery. Furthermore at low temperatures it has only a part of the capacity it has at normal temperatures. We recommend therefore that the battery should be checked preferably in a V.A.G workshop before the onset of cold weather and charged if necessary. At the same time, if necessary, the terminals will be cleaned and special grease applied. This will not only result in quicker, more reliable starting but will help to prolong the life of the battery.

If the vehicle is not driven for several weeks when temperatures are very low, the battery should be taken out and stored in a frost-free room, so that it does not freeze up and become damaged.

Store the battery out of reach of children.

To take battery out, first disconnect the two wires (see "Battery charging - Quick charging") and then remove retainer.

## Charging battery

When charging with a low current (e.g. with a small charger) the connecting wires need normally not be taken off. The instructions from the charger manufacturer must however be noted.

Before **Quick charging**, that is charging with a high current, both connecting wires must be disconnected:

Disconnect minus wire first, then the plus wire.

A discharged battery can freeze at  $-10^{\circ}$  C. It is essential to thaw out a frozen battery before it is given a quick charge as otherwise it may explode!

The mains wire of the charger should not be connected until after the clips of the charger have been properly secured to the battery terminals:

Red = plus (or positive)  
Black = minus (or negative)

### Caution

**The gas given off during the charging process is highly inflammable so keep sources of ignition (naked flames, burning cigarettes etc.) well away from the battery.**

When connecting the battery to the vehicle system again note: Connect plus wire first, then the minus wire.

### Caution

**Do not reverse the polarity on any account, as otherwise the electrical system will be seriously damaged.**

### Notes

- **Never short the battery terminals as this causes the battery to heat up very quickly and it may burst.**
- **To prevent any possibility of short circuiting, detach battery earth wire before doing any work on the electrical system. When changing a bulb, it is sufficient to switch the lamp concerned off.**
- **Never run the engine with the battery disconnected as this will damage the electrical system (electronic components).**
- **Starting by connecting an additional battery is described in the Do-it-yourself section.**

## WHEELS

Wheels and tyres are important design features. The wheels and tyres approved by us are specially matched to the model concerned and contribute largely to the excellent roadholding and safe driving characteristics.

**If you wish to fit your car with non-standard wheels or tyres please note:**

■ For technical reasons it is not possible in every case to use wheels from other vehicles – in certain conditions not even wheels from the same vehicle model.

■ Wheels and wheel bolts are matched to one another.

On changing to a different type of wheel (e.g. alloy wheels or wheels with winter tyres) the correct bolt with the proper length and conical shape must be used. The security of the wheels and the functioning of the brake system depend on this.

■ Using types of wheel and/or tyre which have not been approved by us for your vehicle model can be detrimental to the safety of the vehicle. It can

also affect the vehicle under the Construction and Use regulations.

■ If wheel trim discs are subsequently installed, ensure that the air flow remains adequate to cool the brakes.

V.A.G workshops are fully informed about the possible conversions of tyres, wheels and wheel trims.

Many V.A.G Dealers have an attractive range of tyres and wheels for sale.

### General notes

■ Check tyres for damage from time to time and remove any foreign bodies embedded in treads.

■ To avoid damage to tyres and wheels drive over curbs and similar obstacles very slowly and as nearly at right angles as possible.

If you think that a wheel is damaged, it must be checked by a V.A.G workshop.

■ Keep grease, oil and fuel off the tyres.

■ Replace missing dust caps as soon as possible.

■ Mark wheels before taking them off so that they rotate in the same direction when put back.

■ When taken off, the tyres should be stored in a cool, dry and preferably dark place. Tyres which are not on wheels should be stored in a vertical position.

### New tyres

New tyres do not give maximum grip straight away and should therefore be run in at moderate speeds and a careful style of driving for about the first 100 km. This will help to make the tyres last longer.



## Tyre wear

Tyre life depends to a considerable extent on the following factors:

### Inflation pressure

Pressures which are too high or too low shorten tyre life – quite apart from the detrimental influence on vehicle handling.

At continuous high speeds a tyre in which the pressure is too low flexes more and heats up excessively. **This can cause tread separation and tyre blow out.**

In addition low tyre pressures increase the fuel consumption.

The inflation pressures should therefore be checked twice a month and always before a long trip, not forgetting the spare wheel. Always check pressures when tyres are cold. When warm, the pressure is higher but do not reduce. The pressures are given on page 126 and on left door pillar between the hinges.

### Mode of driving

Fast cornering, hard acceleration and violent braking also increase tyre wear.

### Incorrect wheel alignment

Incorrect wheel alignment not only causes excessive, usually uneven tyre wear but can also impair the car's safe handling. If unusual tyre wear is noticed, contact a V.A.G workshop.

### Wear indicators

At the bottom of the tread of the original tyres there are 1.6 mm high "wear indicators" running across the tread – see Fig. There are 6 – 8 of these indicators – according to make – evenly spaced round the tyre circumference. Marks on the flanks of the tyre (for example the letters "IW1" or triangles) show the locations of the wear indicators.

When tread depth is down to 1 mm – measured at any point on the tread – the official permissible minimum tread depth has been reached (in export countries this figure may differ).

**As worn tyres cannot grip the road surface properly when driving at high**



**speeds on wet roads and the vehicle tends to aquaplane sooner, it is advisable not to let the tyres wear down so far.**

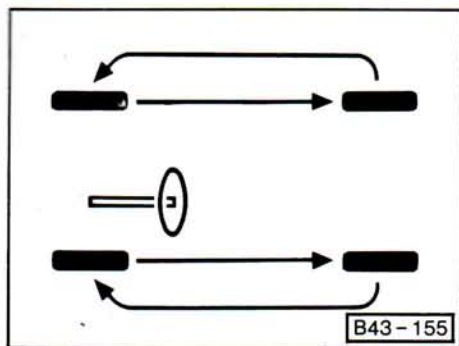

## Changing wheels round

If the tyres are wearing unevenly, it is advisable to change them round as shown. All the tyres will then last for about the same mileage.

When the wheels have been changed round it may be necessary to have the front wheels balanced again.

## Replacing tyres

■ For safety reasons the tyres should be replaced in pairs and not singly. The tyres with the deepest tread should always be on the front wheels.

■ Only radial ply tyres of the same type, size and the same tread pattern may be combined.

■ For safety reasons a **new** rubber valve should be fitted when a new tubeless tyre has been installed.

■ Tubes should only be used in tubeless tyres in an emergency.

When this is done, ensure that the air trapped between tube and tyre can escape from the valve.

■ Repairing tyres calls for special equipment and knowledge and should therefore only be done by a specialist.

**On the Transporter/Caravelle syncro the following should also be noted:**

All four wheels must always be fitted with tyres of the same size, type, tread pattern and make so that the viscous coupling does not engage the front axle drive unnecessarily because of speed

differences between the two axles. If the front wheels have a noticeably smaller roll circumference than the rear wheels so that they turn faster, wind-up will occur in the transmission and cause the tyres to wear quicker.

## Balancing wheels

The wheels on new vehicles are balanced. However when vehicle is running, various influences can cause wheels to become unbalanced and this causes steering vibration.

As imbalance also increases steering, suspension and tyre wear the wheels should be balanced again.

Furthermore a wheel should always be rebalanced when the tyre has been repaired or when a new tyre has been fitted.

## Winter tyres

In winter conditions the handling of the vehicle including four wheel drive vehicles – can be improved by winter tyres. When fitting winter tyres, note the following:

- Only radial ply winter tyres should be used. The factory recommended tyre sizes are given on page 123.
- With winter tyres, the PR figures on the sidewalls should also be noted. The tyres must not be below the specified carcass strength.
- To obtain the best possible handling characteristics, winter tyres must be fitted on all four wheels.
- Winter tyres are no longer fully effective when the tread has worn down to a depth of 4 mm.
- All-weather tyres can be used instead of winter tyres.

## Snow chains

**Snow chains may be used on all the tyre sizes listed on page 123. The chains may be fitted on the rear wheels only.** Only thin chains which do not stand clear more than 15 mm (including tensioner) should be used.

When driving over roads which are free of snow you should remove the chains. On such roads they are detrimental to vehicle handling, damage the tyres and wear out quickly.

In Germany the maximum permissible speed with snow chains is 50 km/h.

### **The following should also be noted on Transporter/Caravelle syncro vehicles:**

Snow chains should, where possible, be fitted on all four wheels. If only two chains are available they must be fitted on the rear wheels.

On vehicles with 16 inch wheels, snow chains may only be fitted on the rear wheels.

Further details about using snow chains are given on page 64.

## EMISSION CONTROL SYSTEM\*

When vehicle is used normally there is nothing special to be noted – apart from putting **lead-free** petrol in the tank. In certain exceptional circumstances the following points should however be observed for safety reasons:

■ **Underbody sealant must not be applied to the catalytic converter or the exhaust pipes.**

■ **Due to the high temperatures which can occur in the catalytic converter in very unfavourable conditions, the vehicle should not be parked so that the catalytic converter can come into contact with easily inflammable materials.**

To ensure that the catalytic converter is not damaged by overheating, the following points must also be noted:

■ **The vehicle must not be started when catalytic converter is at operating temperature by towing it a long distance.**

■ **The ignition must not be switched off as long as vehicle is rolling with a gear engaged.**

■ **If a defect occurs in the ignition system when driving (can be recognized by misfiring, uneven engine running, loss of power) the speed must be reduced immediately. The defect should be eliminated in the next V.A.G workshop.**

In these conditions, unburnt petrol can get into the catalytic converter and be burned there.

A functional description of the emission control system is given on page 117.

## DIFFICULT OPERATING CONDITIONS

The vehicle construction and equipment is designed for normal operating conditions. This also applies to the frequency and the extent of the maintenance laid down in the maintenance schedule.

If the vehicle is used in difficult operating conditions (e.g. continuous trailer towing, exceptionally high or low ambient temperatures, very dusty conditions, poor quality fuel, etc.) it may be necessary to carry out special technical preparations, such as using oil of the appropriate viscosity, installing special air cleaners (cyclone filters), modifying the ignition timing etc. Furthermore the maintenance must also be matched to the operating conditions.

### Driving abroad

If the vehicle is to be taken abroad, the following must also be borne in mind:

- In many countries there is a large network of V.A.G workshops where your vehicle can be serviced. Despite this there are certain countries in which there is only a limited amount of V.A.G service or even none at all.
- In certain countries it is also possible that your vehicle model is not sold so that certain spare parts are not available for your vehicle or that the V.A.G personnel is not familiar with the repair procedure should anything go wrong.

The V.A.G Sales Centres in the Federal Republic of Germany or the Importer concerned will be only too pleased to give advice on the necessary technical preparation of the vehicle, on the maintenance required and on the repair possibilities.

The addresses are given in the vehicle wallet.

- When the vehicle is used in a country which drives on the opposite side of the road to the home country the wedge shaped areas on the headlight lenses must be masked – see page 109.

### Driving on holiday

Before starting off note the following points:

- The roadworthiness and driving safety are particularly important when on holiday see page 57.

■ If your vehicle has a catalytic converter, one must ensure – especially when going abroad – that lead-free petrol will be available during the journey – see page 67. The automobile clubs offer information about the lead-free filling station network.

■ With a fully loaded vehicle and/or roof rack, the handling changes. The driving style must be adapted to the changed conditions – more information on loading is given on page 127.

The tyre pressures must be checked.

■ When a trailer is to be towed, there are many special points to note – see page 60.

■ If an oil change or an Inspection Service is probably going to become necessary during the trip, it is advisable to have this work done before going on holiday if possible.

### Driving in winter

In winter the following points should be noted:

- Winter weather is particularly hard on the battery and it should therefore be checked before the onset of cold weather, preferably by a V.A.G Dealer – see page 85.

If the vehicle is not driven for several weeks when the temperatures are very low, the battery should be taken out – see page 85.

- On vehicles with a Diesel engine, winter Diesel must be used at temperatures below 0° C – see page 69.

- The anti-freeze in the cooling system should be checked before the cold season starts – see page 79.

- The engine oil viscosity must be correct for the ambient temperature – see page 72.

- Particularly in winter, frequent washing and waxing of the vehicle is the best way to protect it against damage from environmental influences.

- The windscreen washer system should always be filled with a window cleaning solution with anti-freeze additive in the winter – see page 80.

- To remove snow and ice from the windows and mirrors, a plastic scraper should be used – see page 94.

- Even on vehicles with four wheel drive the roadholding and handling can be improved in winter road conditions by the use of winter or All-weather tyres – see pages 89 and 126.

- When driving in mountainous districts it is advisable to take snow chains with you in the winter. On some such roads, snow chains are obligatory – and this applies also to four wheel drive vehicles – see pages 64 and 89.

## CAR CARE

**Regular and careful care helps to maintain the value of the vehicle.**

**Furthermore it can be one of the stipulations for the upholding of warranty claims should corrosion damage and paint defects occur.**

Every V.A.G workshop carries stocks of suitable car care materials. The instructions for use on the container should be followed.

#### **Caution**

**These materials can be injurious to health if misused and should be kept out of reach of children.**

#### **Washing**

The best protection against environmental influences is frequent washing and waxing. After the period when salt is put on the roads, the underside of the vehicle should always be washed thoroughly.

When the vehicle is washed in an automatic wash plant nothing need be noted apart from the usual precautions. It is however advisable to fold the outside mirrors inwards.

The longer **salt**, road dust, industrial grime, insects and bird droppings etc. are left on the paintwork the more damage they are liable to do to the finish.

When the load compartment has been cleaned, the sliding door hinges or the side board hinges must be regreased.

When vehicle is washed with a hose, do not point the jet of water directly at the lock cylinders – otherwise they will freeze up in winter.

Tar spots, traces of oil, industrial grime, insects, etc. cannot always be removed by washing. As they damage the paint if left on too long they should be removed as soon as possible with a suitable preparation.

#### **Waxing**

Wax as often as possible. This will prevent dirt from sticking to the paint and industrial grime from penetrating into the paint.

#### **Polishing**

Should only be done if paint has lost its shine and gloss cannot be brought back with wax. If the polish used does not contain preservative compounds, the paint must be waxed afterwards.

**Matt painted and plastic parts** should not be treated with wax or polish.

### Touching up paint damage

Small marks in the paint such as scratches or stone damage should be touched up immediately with paint (Volkswagen touch-up brushes or spray cans) **before** the metal starts to rust.

However, should rust be found at any time it must be removed thoroughly and then the area treated first with an anti-corrosion primer and then the correct paint applied.

You can of course have this work done by a V.A.G workshop.

The number of the original vehicle paint is given on the data sticker (see page 132).

### Windows

Remove snow and ice from windows and mirrors only with a plastic scraper. To avoid scratches due to dirt on the glass, the scraper should only be pushed in one direction and not moved to and fro.

Traces of rubber, oil, grease or silicone can be removed with window cleaner or a silicone remover.

The windows should also be cleaned on the inside at regular intervals.

Do not dry the windows with the leather used for the paintwork because traces of paint cleaner will cause streaks to appear on the glass.

To avoid damaging the **heating element wires** in the rear window do not put stickers over the wires on the inside.

### Windscreen wiper blades

To prevent streaks from forming on the glass the wiper blades should be cleaned regularly with a window cleaning solution. When very dirty and full of insect remains, the blades can be cleaned with a sponge or brush. For safety reasons the wiper blades should be renewed once or twice a year. Wiper blades can be obtained from all V.A.G Dealers.

Changing wiper blades – see page 109.

### Door, lid and window weatherstrips

The weatherstrips will remain flexible and last longer if they are rubbed lightly with a rubber protective compound from time to time. This will also stop the weatherstrips freezing on in the winter.

### Cleaning and lubricating sliding roof runners

In order to ensure that the sliding roof\* continues to operate satisfactorily, it is advisable to clean the runners from time to time, at least however once a year and then to spray them with a silicone lubricant.

### Cleaning plastic

If cleaning with a damp cloth or normal washing is not sufficient, plastic parts and leatherette may only be cleaned with special solvent-free plastic cleaners.

### Cleaning cloth upholstery

Upholstery cloth and similar materials must be cleaned with special cleaners or dry foam and a soft brush.



### Cleaning and care of leather upholstery

A damp cloth is normally all that is required to clean leather covered steering wheels and seats etc.

For a more thorough cleaning job, it is best to use a sponge moistened with a lukewarm solution of a very mild detergent.

Do not wet the leather too much otherwise the water may seep through the stitching.

After cleaning, wipe dry with a soft cloth.

If necessary the leather can be treated with a suitable leather care product. On no account should cleaners or sprays containing solvents be used – these could attack the colouring of the material.

### Care of chromed parts

Remove spots and marks with a chrome cleaner. A chrome protective compound can be applied to give long-term protection. Ensure that the chromed parts are covered completely and uniformly with the compound.

### Cleaning seat belts

Keep belts clean because they may not retract properly if very dirty.

Dirty belts can be cleaned by washing with a mild soap solution without taking the belts out of the vehicle.

Do not have the belts cleaned chemically because the cleaning compounds damage the webbing material. Ensure that the belts do not come into contact with corrosive fluids.

Inertia reel belts should be completely dry before they are allowed to roll up.

### Steel wheels

The wheels and the wheel trims should be cleaned thoroughly at regular intervals when the vehicle is being washed. This will prevent brake dust, dirt and road salt from accumulating on the wheel. Persistent, ingrained brake dust can be removed with an industrial grime remover. Paint damage should be repaired before rust can form.

### Alloy wheels

In order to maintain the smart appearance of alloy wheels for a long period, regular care is necessary. In particular, salt and brake pad dust must be washed off thoroughly at least every two weeks otherwise the surface of the alloy will be damaged. After being washed, the wheels should be treated with an acid-free cleaner for alloy wheels. About every three months it is necessary to give the wheels a good rubbing with hard wax. Paint polish or other abrasive solutions must not be used.

If the protective paint coat has been damaged, e.g. by stone impact, the damaged spots should be dealt with as soon as possible.

### **Cleaning and anti-corrosion treatment of engine compartment**

Particularly in winter when vehicle is frequently driven on salted roads is good corrosion protection very important.

The complete engine compartment should therefore be thoroughly cleaned before and after the salting period and then given anti-corrosion treatment so that the salt cannot have a damaging influence.

V.A.G dealers have stocks of the cleaning and preservation solutions recommended by the factory for this purpose and have the equipment necessary to apply them.

### **Undercoating**

The underside of the vehicle is coated with a special compound to protect it from chemical and mechanical influences.

However, as this protective layer gets damaged when the vehicle is in use, the coating under the body and on the running gear should be examined at certain intervals – preferably before and after the winter season – and any damage made good.

V.A.G workshops have stocks of the correct compound, have the necessary equipment and are familiar with the application procedure. We advice you therefore to have the patching up or additional coating done by a V.A.G workshop.

### **Note for vehicles with a catalytic converter**

Due to the high temperatures which occur in the afterburning process, additional heat shields are fitted over the catalytic converter. Underbody sealant must not be applied to these shields, the catalytic converter or the exhaust pipes.

## MAINTENANCE

As the vehicle is fitted with modern low maintenance technical components only a small amount of regular servicing is required in order to maintain the roadworthiness, economy and reliability.

The high manufacturing quality and the selection of high-class materials have made it possible to dispense with a special service immediately after the running-in period. On vehicles with a Diesel engine a First Service must be carried out after 1000 km.

The inspection service offered by the V.A.G workshop takes into account to a large extent the individual annual mileage covered and helps thus to keep the costs as low as possible. An **Inspection Service** is required every **12 months** or every **30000 km**, whichever comes first.

If a mileage of 15000 km (petrol engines) or 7500 km (Diesel engines) is reached before 12 months has elapsed, an **Oil Change Service** must be carried out. See also page 73 and the Service Schedule.

The Service Schedule also shows what work is required at the Inspection and Oil Change Services.

In difficult operating conditions, e.g. extremely low ambient temperatures, very dusty conditions, buildings site work, etc. certain service operations should be carried out between the intervals given.

This applies in particular to:

- Changing the engine oil
- Cleaning or changing the air cleaner element
- Draining water from or renewing the fuel filter on the Diesel engine.
- Lubricating the hinges of sliding and Double Cab doors, dropsides, locker lid and rear doors.

The service operations should be carried out in a V.A.G workshop because this work requires special knowledge, workshop appliances and special tools. Furthermore this work must be done in accordance with our instructions.

The disposal of old oil, used brake fluid, dirty coolant, old batteries or worn-out tyres etc. must be done according to environmental protection regulations.

Complete proof of servicing by a V.A.G workshop can be one of the stipulations for the upholding of any warranty claims during the one year warranty period.

Safety regulations and anti-pollution laws place very strict limits on the amount of repairs and adjustments to engine and running gear parts which can be done by the owner. By tinkering with parts which affect the safety of the vehicle one can endanger oneself and other road users.

In addition, altering the settings of the carburetor or fuel injection system or the ignition, changes the emission values and also increases the fuel consumption.

### Caution

**Special care must be taken when working in the engine compartment! Particular sources of danger are rotating parts (belt pulleys, radiator fans etc.), the electrical system (short circuit dangers, high tension ignition) and the hot, pressurized cooling system. The warnings given in this manual and the normal valid safety rules must be heeded.**

## CARE AND MAINTENANCE

### LIFTING VEHICLE

#### Vehicle hoist

Before driving over a vehicle hoist ensure that there is sufficient clearance between hoist and low parts of vehicle.

The vehicle may only be lifted at the points shown here.

#### Trolley jack

The vehicle should also only be lifted with a trolley jack at the points shown here.

To prevent damage it is essential to use a suitable piece of rubber or wooden packing.

**On no account should the vehicle be lifted under the engine sump, gearbox, rear axle or the front axle as this can cause serious damage.**

#### Vehicle jack

Using the jack is described on the following pages.

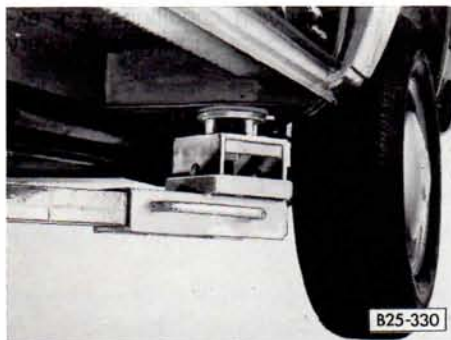

#### Lifting points for hoist and trolley jack.

##### Front

At the front jacking point



##### Rear

At rear cross member

**FIRST AID KIT, WARNING TRIANGLE**

The First Aid kit and triangle can be stowed, depending upon the vehicle version, either under the left hand front seat or under the rear seat bench.

**Note**

The First Aid kit and triangle are not part of vehicle equipment.

**TOOLS, JACK**

The jack and tools are located under the left hand seat. They can be taken out when the seat is pushed fully forward and the cover underneath lifted up.

On vehicles with a second battery or a swivelling seat, the tools and jack are located either behind the left hand seat or under the rear seat, depending on arrangement of seats in passenger compartment. The trim under the rear seat can be pulled out to the front.

The screwdriver blade is reversible.

## SPARE WHEEL

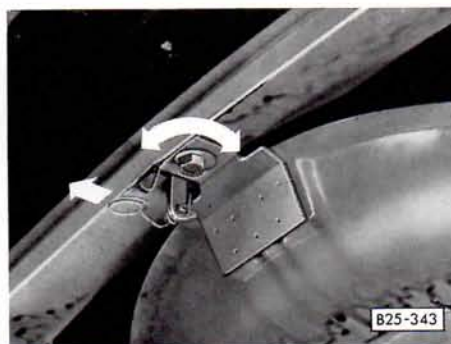

The spare wheel is either located on a hinged pan under front of body or at rear in luggage compartment.

The spare wheel in luggage compartment is bolted to the left side panel. To remove wheel, take bolt out by hand.

**For safety reasons the spare wheel must always be bolted securely to side panel when vehicle is moving.**

To take **wheel under body** out, remove bolt with wheel nut spanner and pull hook away.

**Caution: Keep clear as the pan falls down. Danger of injury.**

Then pull wheel forward off the pan.

### Note

On vehicles with a front spoiler, it may be necessary to take weight off front of vehicle before removing the spare wheel. If necessary the front can be lifted slightly with the jack or the spoiler taken off.

To stow spare wheel, place it on the pan with offset downwards and swing pan up until hook engages. Then insert bolt and tighten it.

**For safety reasons the pan must always be bolted in position so that it cannot release accidentally.**

## CHANGING WHEELS

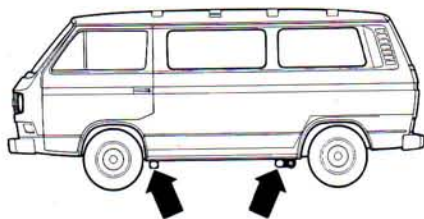

B25-319

■ Apply handbrake firmly. If the vehicle is on a slope, place a stone or some similar object behind one of the wheels on the opposite side.

The wheel trim caps are removed with the bar and wire hook:

Place hook in the two holes on edge of cap, insert bar through hook and lever cap off.

■ Loosen wheel nuts/bolts with box spanner and bar approximately one turn.

■ Insert jack into the appropriate lifting socket (Fig.) as far as possible. If necessary, clean the socket beforehand. Place jack vertically.

If ground is soft, place a large strong piece of packing under the jack base plate.

■ Lift vehicle until the wheel is clear of the ground.

■ Remove bolt/nuts and take wheel off.

■ On vehicles with alloy wheels, change the wheel hub cap.

■ Fit spare wheel and tighten bolts/nuts lightly first.

**To ensure that the wheel is secured properly the contact surfaces to the wheel hub or drum and for the wheel nuts/bolts must not be dirty or rusty.**

■ Lower vehicle to ground and tighten the bolts/nuts in a diagonal sequence.

■ Install trim cap.

## Notes

When a wheel has been changed, the tyre pressure in the wheel which has been fitted and the tightening torque of the wheel bolts should be checked as soon as possible. Use a torque spanner for the bolts. The torque for the wheels supplied by the factory is 170 Nm (17 kgm).

## Caution

**The jack supplied by the factory is only designed to lift your vehicle model. On no account should heavier vehicles or other loads be lifted. Do not work under the vehicle when it is on the jack.**

If the vehicle is to be subsequently fitted with wheels or tyres which differ from those fitted by the factory, it is essential to read the remarks on page 86.

## FUSES

The fuses are located on right under the dash behind a cover.

### To take cover off

Detach cover at front, swing it down and unhook it.

### To put cover back

Hook cover into eyes on mounting for fuse box, swing it up and press into position.

### Changing a fuse

- Switch off the component concerned.
- With the aid of the list of fuses, find out which fuse belongs to the component which has failed.
- Pull out the blown fuse with the plastic clip (located on the cover in front of fuse box).
- Replace blown fuse – can be recognised by the burnt metal strip – with a fuse of **same capacity**.

Spare fuses can be inserted on the underside of the fuse box. These fuses can be obtained from a V.A.G workshop.

### Notes

- If the newly inserted fuse blows again after a short time, the electrical system must be checked by a V.A.G workshop as soon as possible.
- On no account should fuses be patched up because this can cause serious damage elsewhere in the electrical system.

### Fuse layout

see next page.



**Fuse layout**

(from left to right)

No.	Component	Amp.	No.	Component	Amp.
1	Radiator fan	30	13	Fresh air blower	20
2	Brake lights	10	14	Rear window heating, electric mirror heating, lighting switch light	20
3	Reading lamps, interior lights, illuminated make-up mirror, clock, cigarette lighter, radio	15	15	Reversing lights	10
4	Emergency light system	15	16	Horn, dual tone horn	15
5	Vacant		17	Windscreen wiper motor	10
6	Fog lights	15	18	Brake warning lamp, heated driving seat, cruise control, belt warning system	10
7	Tail and side light left	10	19	Turn signals	10
8	Tail and side light right	10	20	Number plate light, headlight washer	10
9	Headlight right	10	21	Low beam left	10
10	Headlight left	10	22	Low beam right	10
11	Windscreen wiper and washer switch	15			
12	Additional heat exchanger, electric windows, cruise control, electric outside mirror, auxiliary heater, A/C, rear window wiper	20			

**Additional fuses in holders**

## ■ under right rear seat:

Reading lamp, right rear	8
Luggage compartment lights	8
Electrically adjustable seat right	16
Electrically adjustable seat left	16

## ■ above fuse box:

Instrument lighting	10
Rear fog light	10
Overheating fuse for auxiliary heater	10
Main fuse for auxiliary heater	20
Emergency horn	15
Central locking	20
Automatic fuse for electric windows	20
Rotating warning lamp	15

■ In engine compartment on left  
in black box.

Diesel glow plug system <sup>1)</sup> –	50
---	----

## CHANGING BULBS

Before starting to replace a bulb, switch off the light concerned.

Do not touch the glass part of the new bulb with bare fingers because the finger marks left on the glass evaporate when the bulb gets hot, the vapour settles on the reflector and dims it.

Always use the same type of bulb. The designation is marked on the base of the bulb.

It is advisable to always carry a box of spare bulbs in the vehicle. This can be obtained from a V.A.G dealer.

For safety reasons this box should contain the following bulbs.

- 12 V 60/55 W – Main headlight (H 4)
- 12 V 4 W – Side lights and number plate light
- 12 V 10 W – Taillight
- 12 V 2 W – Stoplight and turn signal



### Headlight

To change a headlight bulb or side light bulb the headlight must be taken out:

Turn 5 quick-release clips in upper grille 90° with a screwdriver. Pull grille forward slightly at the top and lift it out. Then remove screws (see Fig.) and take headlight out.

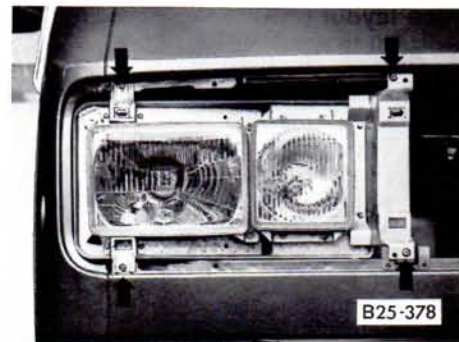

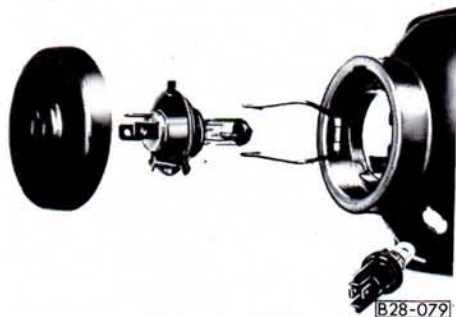

### Main headlight bulb

(Halogen H 4)

- Pull connector off.
- Take cap off.
- Squeeze spring clip of the bulb holder together and fold it clear.
- Take bulb out and insert new bulb so that the locating lug on the bulb plate engages the recess in the reflector. The centre one of the three terminals on bulb base is then at the top.

- Fold spring clip over bulb base. Squeeze clip together and engage it in the retaining lugs.
- Press cap back on.
- Attach connector.
- Install headlight and air intake grille again.
- Have headlight beam alignment checked.

### Side light bulb

The side light bulbs are located in the headlight reflectors.

- Turn bulb holder fully to the left and take it out of reflector.
- Press defective bulb into holder turn it to left and take it out.
- Insert new bulb.
- Insert bulb holder in reflector and turn holder fully to the right.

### Headlight bulb (H3)\*

(Inner headlight on vehicles with dual headlights.)

- Turn cap to left and take off.
- Pull wire connector off.
- Unhook spring clip holding bulb and swing it away.
- Take bulb out and insert new bulb so that the locating lug on bulb plate engages recess in reflector.
- Swing spring clip over bulb plate. Squeeze clip together and engage it in the retaining lugs.
- Attach wire again.
- Install cap and turn to right.
- Have headlight setting checked.

### Fog lights (H3)\*

- Remove screw on underside of fog light.
- Take insert out.
- Pull wire for bulb out of cable connector.
- Unhook spring clip and fold it away.
- Take bulb out. Insert new bulb so that locating lug on reflector engages recess on bulb plate.
- Swing clip over bulb plate. Squeeze ends together and engage in retaining lugs.
- Insert bulb wire in cable connector.
- Install insert – upper side first – in the housing and secure with screw.
- Have setting of light checked.

### Rear lights

- Remove screws and take off lens and bulb holder.
- Squeeze tabs together and take holder out. (On some versions there is only one tab.)
- Press bulb in, turn it to left and take it out.
- Fit new bulb.
- Install holder – tabs must engage – and install screws.

### Front turn signals

- Take lens off.
- Pull rubber cap off.
- Press tab on bulb holder inwards and take holder out of housing.
- Turn bulb slightly to left and renew.
- Press rubber cap on again carefully and install lens.

**Number plate light**

The number plate lights are pushed into the cross panel from the rear.

- Press lugs together and pull light housing out to the rear.
- Remove lens.
- Press bulb into holder, turn it to the left and renew it.
- Install lens.

Ensure that the lug in the lens engages the opening in the bulb-holder as otherwise the number plate will not be illuminated properly.

- Do not overtighten lens screws.
- Install light again. Ensure that housing fits over the metal tab at the top and engages the hole in cross panel at the front.

**Interior light**

- Press retaining spring at opposite end to switch inwards and take light out.
- Renew bulb.
- Insert light at switch end first.

**Reading lamps\***

- Lever adjusting ring out at side recess with flat blade of screwdriver.
- Press bulb into fitting slightly, turn it to right and take it out.
- Install new bulb.
- Fit adjusting ring so that recesses in ring are in line with those on lamp housing.
- Press adjusting ring on.

**Table light\***

- Push flat screwdriver blade behind light housing on left so that the spring behind it is pushed to one side and then lever housing off.
- Pull reflector out.
- Change bulb.
- Insert reflector again.
- Push lug on right of lamp housing behind trim on right first and then press light on.

**Interior light in front of passenger seat, step light, luggage compartment lights.\***

- Lever glass out at side with flat screwdriver blade.
- Change bulb.
- Press glass into the trim again.

## DO-IT-YOURSELF

### ADJUSTING HEADLIGHTS

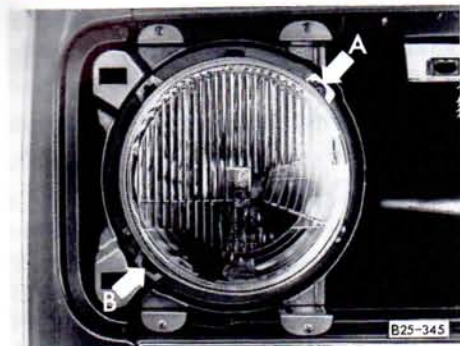

Correct headlight adjustment is very important for vehicle and traffic safety. The adjustment should therefore only be done with a special appliance.

The headlights are adjusted from the front through the grille with a Phillips screwdriver.



The illustrations show the adjusting screws for the right headlight. The screws for the left headlight are symmetrically opposite.

A – Lateral setting

B – Vertical setting

Turning screw to right lowers the headlight beam.

## MASKING HEADLIGHTS

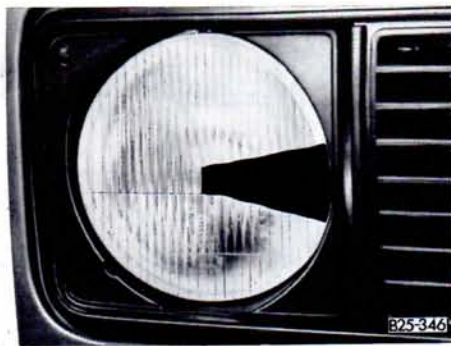

When the vehicle is used in a country which drives on the opposite side of the road to the home country, the asymmetric headlights will dazzle oncoming traffic.

To prevent this, the wedge-shaped sector on the headlight lenses must be covered up with an opaque adhesive strip.

The illustration shows the strip installed for the change from right hand to left hand traffic.

## CHANGING WIPER BLADES

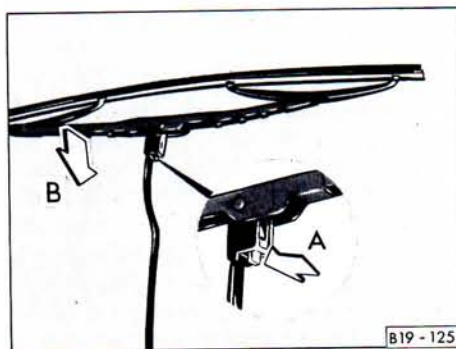

Good wiper blades are essential for clear vision. For this reason they should be renewed once or twice a year.

### Taking wiper blade off

- Hinge wiper arm up and position blade horizontally.
- Press retaining spring (arrow A) and push blade towards screen at the same time (arrow B).

### Securing wiper blade

The retaining spring must engage audibly in the wiper arm.

### INSTALLING A RADIO SET

---

The following points should be noted when installing a radio set:

■ It is advisable to use radio sets from the V.A.G Accessory programme as well as the fitting kits, aerials and suppression sets which have been specially developed for the individual vehicle model and are available from all V.A.G workshops. These parts are supplied with detailed fitting instructions.

The use of other parts or parts from the previous models may because faulty operation of the system. Furthermore the installation of non-approved suppression sets can affect the registration of the vehicle under the Construction and Use regulations in cases of doubt V.A.G workshops will advise.

■ When installing the aerial it is essential to ensure that the hole provided by the factory where the aerial enters the body is sealed very carefully. In addition the aerial cable, the connecting wires and loudspeaker wires must be routed so that they cannot chafe, rattle or get tangled up with moving parts (e.g. pedals, steering, heating controls etc.). Otherwise the operation of the controls may be affected or vehicle safety impaired.

■ The wiring is already installed at the radio fitting location. The plug on this wiring loom fits all radio sets in the V.A.G Accessory Programme which have a separate connection for the scale lighting.

Radio sets with other connections must be connected with an adapter wire which can also be obtained from V.A.G workshops. If the adapter wire is not used or if wires are cut off and left without insulation there is a risk of short circuiting. **This can cause the wiring to burn out.**



## EMERGENCY STARTING

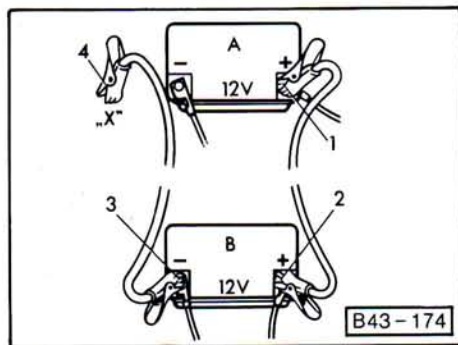

A - Flat battery  
B - Boosting battery

The battery is under the right hand seat in the cab.

On vehicles with a Diesel engine it is in the engine compartment.

If the engine will not start because the battery is flat, **jumper cables** can be connected to the battery of another vehicle to start the engine. The following points should be noted:

- Both batteries must be 12 Volt types. The capacity (Ah) of the boosting battery must not be a lot lower than that of the flat one.

- Use only jumper cables with insulated clips.

- The jumper cables must be heavy enough to carry the load. Note cable manufacturer's data.

- A flat battery can freeze at  $-10^{\circ}\text{C}$  and if a battery is frozen it must be thawed out before connecting a jumper cable as otherwise it could explode.

- There must be no contact between the vehicles otherwise current can flow as soon as the plus terminals are connected.

- The flat battery must be properly connected to the electrical system.

- The engine of the boosting vehicle must be running.

- Connect jumper cables only as follows:

1. One end of (+) cable (usually red) to the (+) terminal of flat battery.
2. Other end of red cable to (+) terminal of boosting battery.
3. One end of (-) cable (usually black) to (-) terminal of boosting battery.
4. Other end of black cable (x) to the bolt securing earth wire to body.

Do not connect the cable to the battery minus terminal. The sparks could ignite the explosive gas flowing out of the battery.

**Caution**

Take great care to ensure that the non-insulated parts of the jumper cable clips do not touch one another and that the plus cable does not touch current conducting vehicle parts - short circuit danger.

- Route the jumper cables so that they cannot come into contact with rotating parts in the engine compartment.

- Do not stand with your face over the battery - danger of acid burns.

- Keep ignition sources (naked flames, burning cigarettes etc.) well away from the battery - Explosion danger!

- Start the engine as described in the "Starting and Stopping Engine" section.

If the engine does not start straight away, stop trying after about 10 seconds, wait about half a minute and then try again.

- When engine is running, disconnect cables in reverse sequence.

### TOW STARTING/TOWING

#### General remarks

■ Towing eyes are provided at front and rear on the right underneath the bumpers.

Towropes or bars should be attached at these points only.

■ The towrope should be slightly elastic to reduce the risk of damage to both vehicles. It is advisable to use only ropes of synthetic materials or with elastic links. **It is however safer to use a tow bar.**

Avoid excessive towing effort and do not jerk. During towing operations on other than surfaced roads there is always the danger that the attachment points will be overloaded and damaged.

■ **Before trying to start engine by towing, the battery from another vehicle should be used for starting if possible** – see previous page.

**If the vehicle has to be tow started or towed at any time, the following must be noted:**

■ Traffic regulations regarding towing must be observed.

■ Both drivers must be familiar with towing procedures. Inexperienced drivers should not attempt to tow start or tow.

■ When using a towrope the driver of the towing vehicle must engage the clutch very gently when moving off and changing gear.

■ The driver of the vehicle being towed must ensure that the towrope is always taut.

■ The emergency lights must be switched on on both vehicles – unless local regulations differ.

■ Turn ignition key to "Drive" position so that the steering wheel is free and the turn signals, horn, and, if necessary, the windscreen wiper and washer can be used.

■ As the brake servo only works when the engine is running, more pressure is required on the brake pedal when the engine is not running.

■ On vehicles with power assisted steering more force is required to turn steering wheel when engine is not running.

■ When there is no lubricant in the manual or automatic gearbox the vehicle may only be towed with driving wheels lifted.

## Tow starting

The following points must be noted when tow starting:

- Before moving off, engage 2nd or 3rd gear.
- Switch ignition on.
- As soon as engine starts, depress clutch and move gear lever into neutral to avoid running into the towing vehicle.
- **On vehicles with a catalytic converter the engine must not be started when catalytic converter is at operating temperature by towing the vehicle a long distance as otherwise unburnt petrol can get into the catalytic converter and be burned there.**
- For technical reasons the tow starting of a vehicle with an automatic gearbox is not possible.

## Towing

When towing vehicles with an automatic gearbox, the following points must be noted in addition to the details on the previous page:

- Selector lever at "N".
- Do not have vehicle towed faster than 30 mph (50 km/h).
- Do not tow further than 30 miles (50 kilometers).

If the vehicle has to be towed long distances it must be lifted at the rear.

Reason: When the engine is not running, the gearbox oil pump is not working and the gearbox is not adequately lubricated for high speeds or long distances.

The following should also be noted on four wheel drive vehicles:

If the vehicle has to be towed with either front or rear axle lifted, one must ensure that the wheels on the raised axle are free to rotate. If this is not possible, the vehicle may only be moved with all four wheels on a recovery vehicle or a trailer.

## ENGINE

### Petrol engines

- 4 stroke petrol engine
- 4 cylinder horizontally opposed
- Cast-iron cylinders
- 4 bearing crankshaft
- Light alloy cylinder heads
- Light alloy crankcase
- Valves operated via push rods and rocker arms
- Maintenance free valve gear with hydraulic tappets
- Cooling system filled for life of vehicle
- Radiator with separate expansion tank
- Electric radiator fan controlled by thermo switch
- Low maintenance electronic ignition system.
- Single or twin choke down draft carburetor (44, 54 or 57 kW engines)

- Petrol injection system\* with over-run fuel cut-off
- Emission control system\*
- Thermostatically, controlled intake air preheating and electrical mixture preheating.
- Dry air cleaner with paper element, cyclone filter for very dusty countries\*
- Long life spark plugs
- Optical and acoustic oil pressure monitor\*

### Diesel engines

- Four stroke Diesel engine, installed longitudinally, inclined 50°
- 4 cylinders in line
- Cast iron block
- 5 bearing crankshaft
- Sheet metal sump
- Light alloy cylinder head
- Valves operated by overhead camshaft, toothed belt drive
- Liquid cooling
- Radiator with separate expansion tank
- Thermostat controlled electric fan
- Mechanical fuel injection
- Distributor type injection pump with cold starting aid, exhaust turbocharger on 51 kW engine
- Preheated fuel filter\*
- Dry air cleaner with paper element.

## POWER TRANSMISSION

---

### Manual gearbox

- Hydraulically operated single plate clutch
- Baulk synchronized four or five speed manual gearbox with final drive in one housing
- Filled for life.
- Rear wheel drive

### Transporter/Caravelle syncro

- Baulk synchronised 4-speed manual gearbox with additional cross country gear (4+G gearbox).
- Permanent four-wheel drive through viscous coupling.
- Manually operated differential locks for front and/or rear final drives available as optional extra.

### Automatic gearbox\*

- Hydro-dynamic torque converter and planetary gear train with three forward speeds and reverse
- Final drive flanged on
- Rear wheel drive
- Filled for life.

## STEERING

---

- Maintenance free rack and pinion steering with relay idler
- Safety steering column
- Power assisted steering\*

## TECHNICAL DESCRIPTION

### AXLES

---

#### Front axle

■ Independent wheel suspension with wishbones/track control arms, coil springs and telescopic dampers

■ Anti-roll bar

#### Additional on Transporter/Caravelle syncro

■ Double jointed shafts

■ Differential lock\*

■ Wear-free viscous coupling

#### Rear axle

■ Independent suspension with diagonal trailing arms, coil springs and telescopic dampers

■ Double jointed drive shafts

#### Additional on Transporter/Caravelle syncro

■ Differential lock\*

### BRAKES

---

■ Hydraulic dual circuit brakes

■ Disc brakes at front

■ Self-adjusting drums at rear with retardation-sensitive pressure regulator

■ Brake servo

■ Mechanical handbrake effective on rear wheels

Anti-locking brake system (ABS)\*

### BODY

---

■ Unitary body/chassis

■ Floor frame reinforced by side and cross members

## EMISSION CONTROL SYSTEM\*

### Functional description

The emission control system effectively reduces the amount of pollutants in the exhaust gas. The system is so designed that it requires no additional maintenance. With normal vehicle use, no special operating instructions need be observed – apart from filling the tank with lead-free petrol. Only in certain exceptional cases is it necessary, for safety reasons, to note a few points – see page 90.

The main parts of the emission control system are

- A mixture formation system which guarantees very exact composition of the air/petrol mixture at all engine speeds
- the catalytic converter
- the Lambda probe<sup>1)</sup>

<sup>1)</sup> Lambda = Air/petrol relationship

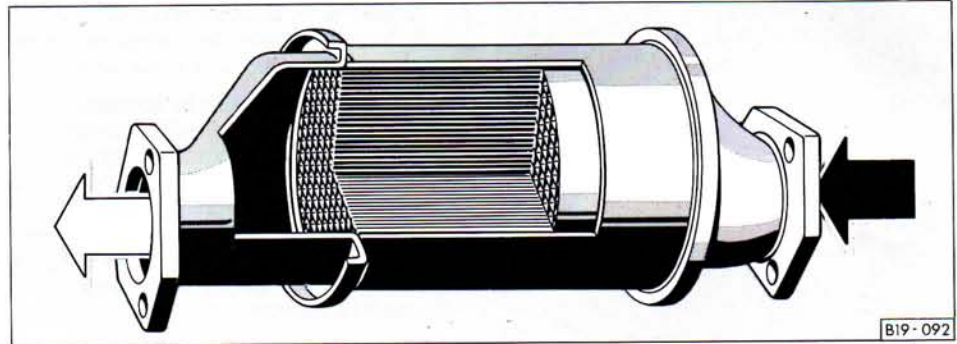

The catalytic converter is installed in the exhaust pipe. It is a so-called three-way catalytic converter and consists of a steel-cased ceramic body containing a multitude of longitudinal passages which are vapour coated with a thin layer of platinum or rhodium.

The exhaust gas flows through the catalytic converter and reacts with an afterburning process when it contacts the noble metal coating. In this process three pollutants (three-way catalytic converter) are converted to harmless substances as follows

- Carbon monoxide to carbon dioxide
- Hydrocarbons to water
- Nitrogen oxide to nitrogen (four fifths of the air we breathe is nitrogen).

A stipulation for the proper functioning of the catalytic converter, however, is that the exhaust gas has a certain specific composition and minimum temperature when it enters the catalytic converter. To obtain this composition exact regulation of the fuel/air mixture is required. A very exact regulation is obtained on vehicles which are fitted at the factory with a Lambda probe<sup>1)</sup>.

### ACTIVATED CHARCOAL FILTER\*

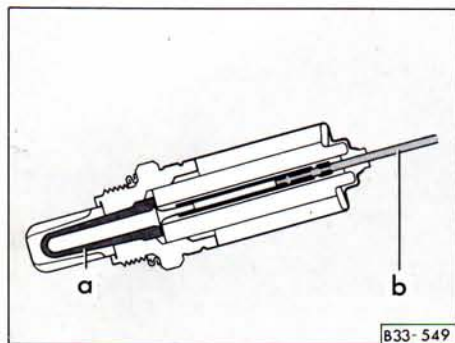

a – Sensor with noble metal coating

b – Connecting wire

**The Lambda probe<sup>1)</sup>\*** is fitted in the exhaust pipe in front of the catalytic converter and measures the exhaust gas composition continuously. The information signal is fed to an electronic control unit which in turn regulates the mixture formation system so that the mixture is kept constantly correct.

<sup>1)</sup> Lambda = Air/petrol relationship.

A special tank ventilating system effectively prevents fuel vapour in the tank from escaping into the atmosphere.

The vapour is passed to a container filled with activated charcoal. When engine is not running the fuel content of this vapour is retained by the activated charcoal. When the engine is running a valve opens and allows air to flow through the container and take the fuel vapour to the engine for combustion. The system requires no attention or maintenance.



Where not otherwise indicated or listed separately, all technical data is for standard vehicles with and without a catalytic converter in Germany.

**For special vehicles and vehicles for other countries these figures may be different.**

**Please note that the details in the official vehicle documents can be taken as the correct figures.**

The DIN figures are determined in accordance with the standards issued by the German Standards Institution.

## ENGINE DATA

	Output <sup>1)</sup> kW (bhp) at rpm	Maximum torque Nm at rpm	Number of cylinders	Cap- acity cm <sup>3</sup>	Stroke mm	Bore mm	Comp- ress- ion	Mixture formation	Fuel <sup>2)</sup>
Petrol engines with catalytic converter (US Standard)	<b>70</b> ( 95)/4800	160/2800	4	2109	76	94	9,0	Fuel injection	Regular lead-free
Petrol engines without catalytic converter	<b>44</b> ( 60)/3700	140/2200	4	1913	68,9	94	8,6	Carburetor	Regular lead-free/leaded
	<b>57</b> ( 78)/4400	153/2600	4	1913	68,9	94	8,6	Carburetor	Regular lead-free/leaded
	<b>82</b> (112)/4800	174/2800	4	2109	76	94	10,5	Fuel injection	Premium leaded
Diesel engines	<b>37</b> ( 50)/4200	103/2000	4	1588	86,4	76,5	23,0	Fuel injection	Diesel
	<b>42</b> ( 57)/4500	103/2800	4	1715	86,4	79,5	23,0	Fuel injection	Diesel
	<b>51</b> ( 70)/4500	138/2500	4	1588	86,4	76,5	23,0	Fuel injection	Diesel

[www.WestfaliaT3.info](http://www.WestfaliaT3.info) - a useful website for owners and enthusiasts of VW Westfalia T25 / T3 / Vanagon Campervans

<sup>1)</sup> According to DIN 70020 Part 6.

<sup>2)</sup> For minimum octane or Cetane rating and further details see pages 68 and 69.

## FUEL CONSUMPTION

### Passenger models l/100

The consumption figures were determined in accordance with DIN 70030 Part 1 (July 1978 Edition). The figures in brackets were determined by a slightly different method of measuring (UTAC).

The basis for both consumption measurements is Recommendation A 70 of the EEC. The tests are carried out in three different conditions:

- The measurements for 90 km/h (56 mph) and
- 120 km/h<sup>1)</sup> (75 mph) are carried out at a constant test speed.
- For the urban measurement normal town traffic driving is simulated.

Depending on driving style, road and traffic conditions, environmental influences and vehicle condition, the figures obtained in actual practice may differ from those given.

All figures were measured with standard tyres. On vehicles with other tyres the figures will vary accordingly.

To get mpg, divide 282.5 by the number of litres (DIN or UTAC).

Carburetor engines	44 kW		4 speed	57 kW		Automatic	syncro 4 + G
	4 speed	5 speed		5 speed	4 speed		
Caravelle and combi 90 km/h 120 km/h <sup>1)</sup> Urban	9.7 (10.5)	9.7 (10.8)	9.5 ( 9.7)	9.4 ( 9.5)	10.7 (11.2)	11.2 (10.6)	
	12.9 (12.9)	11.8 (11.9)	13.9 (12.8)	10.9 (13.9)	13.8 (12.6)	14.9 (12.8)	
High-roofed Combi 90 km/h 120 km/h <sup>1)</sup> Urban	11.5 (11.2)	11.0 (10.8)	10.5 (10.6)	10.3 (10.2)	12.2 (12.4)	12.3 (11.9)	
	12.9 (12.9)	11.8 (11.9)	13.9 (12.8)	10.9 (13.9)	13.8 (12.6)	14.9 (13.5)	

<sup>1)</sup> Valid only for vehicles with a top speed of more than 130 km/h.

<b>Petrol injection engines</b>		70 kW			82 kW			
		5 speed	Automatic	syncro 4 + G	5 speed	Automatic	syncro 4 + G	
Caravelle and combi								
90 km/h	l/100 km	9.8	12.5	12.1	8.8 ( 9.4)	9.6 (10.3)	10.1 (10.4)	
120 km/h <sup>1)</sup>	l/100 km	14.5	16.8	17.1	13.1 (12.9)	13.5 (14.8)	15.4 (15.7)	
Urban	l/100 km	15.5	16.5	16.1	12.0 (12.3)	13.8 (14.0)	13.9 (12.4)	
High-roofed Combi								
90 km/h	l/100 km	10.7	13.9	13.4	9.8	11.1	10.8 (11.0)	
120 km/h	l/100 km	15.8	18.4	-	14.3	15.1	16.2 (17.1)	
Urban	l/100 km	15.5	16.5	16.1	12.0	13.0	13.9 (12.1)	
Caravelle Carat								
90 km/h	l/100 km	10.0	13.2	-	9.0 ( 9.4)	9.8 (10.5)	-	
120 km/h	l/100 km	14.7	17.8	-	13.3 (13.0)	13.7 (14.9)	-	
Urban	l/100 km	16.1	17.1	-	12.6 (12.6)	14.4 (14.4)	-	
<b>Diesel engines</b>		37 kW		42 kW		51 kW		syncro 4 + G
		4 speed	5 speed	4 speed	5 speed	4 speed	5 speed	
Caravelle and combi								
90 km/h	l/100 km	9.1 (9.0)	8.0 ( 7.7)	8.5	8.0	8.3 (7.6)	7.9 (7.5)	8.8 (8.7)
120 km/h	l/100 km	-	-	-	-	-	-	-
Urban	l/100 km	9.1 (9.0)	9.6 (10.1)	8.9	9.8	8.6 (8.0)	8.7 (6.7)	9.7 (8.1)
High-roofed Combi								
90 km/h	l/100 km	9.8 (9.7)	9.0 ( 8.7)	9.4	8.9	9.2 (8.2)	8.9 (8.1)	9.7 (9.4)
120 km/h	l/100 km	-	-	-	-	-	-	-
Urban	l/100 km	9.1 (9.0)	9.6 (10.1)	8.9	9.8	8.6 (8.0)	8.7 (6.7)	9.7 (8.1)

## TECHNICAL DATA

### Commercial vehicles

l/100 km

These consumption figures were determined in accordance with DIN 70030 Part 2 (July 1978 Edition) with half payload at a constant 3/4 of top speed plus 10%.

Depending on driving style, road and traffic conditions, environmental influences and vehicle condition, the figures obtained in actual practice may differ from those given in the standards.

All figures were measured with standard tyres. On vehicles with other tyres the figures will vary accordingly.

To get mpg, divide 282.5 by the number of litres.

Figures in l/100 km

Carburetor engines	44 kW		57 kW			
	4 speed	5 speed	4 speed	5 speed	Automatic	syncro 4 + G
Van	10.9	10.9	11.7	11.4	12.5	13.1
High roofed Van	11.7	11.2	12.1	12.5	13.4	13.5
Pick-up	11.7	11.7	12.3	11.9	12.9	13.7

Petrol injection engines	70 kW			82 kW		
	5 speed	Automatic	syncro 4 + G	5 speed	Automatic	syncro 4 + G
Van	13.1	15.1	15.2	12.9	13.3	15.1
High roofed Van	13.9	16.5	15.9	13.6	14.5	15.7
Pick-up	13.6	15.9	15.5	13.3	13.9	15.4

Diesel engines	37 kW		42 kW		51 kW		
	4 speed	5 speed	4 speed	5 speed	4 speed	5 speed	syncro 4 + G
Van	8.3	7.6	8.8	8.1	8.6	9.1	9.9
High roofed Van	8.9	7.9	9.2	8.5	10.6	10.2	11.9
Pick-up	8.6	8.1	8.8	8.7	9.6	9.1	10.9

[www.WestfaliaT3.info](http://www.WestfaliaT3.info) - a useful website for owners and enthusiasts of VW Westfalia T25 / T3 / Vanagon Campervans

**PERFORMANCE**

**Maximum speed**  
approx in km/h

The maximum speeds were measured according to DIN 70020 Part 3. Vehicle not fitted with any equipment such as mud flaps which affects the performance.

All figures were measured with the standard tyres. On vehicles with other tyres the figures will vary accordingly.

<b>Carburetor engines</b>	44 kW		57 kW		57 kW syncro 4+G
	4 speed / 5 speed		4 speed / 5 speed	Automatic gearbox	
Caravelle, Combi, Van, Double Cab . . .	118		130	125	125
High roofed Van . . . . .	113		125	120	120
Pick-up, Large platform Pick-up . . . . .	115		127	122	122

<b>Petrol injection engines</b>	70 kW		70 kW syncro 4+ G	82 kW		82 kW syncro 4+ G
	5 speed	Automatic		5 speed	Automatic	
Caravelle, Combi, Van, Double Cab . . . . .	141	136	135	150	146	142
Caravelle Carat . . . . .	141	136	—	150	146	—
High roofed Van . . . . .	136	131	130	145	141	137
Pick-up, Large platform Pick-up . . . . .	138	133	132	147	143	139

<b>Diesel engines</b>	37 kW		42 kW		51 kW		51 kW syncro 4+ G
	4 speed	5 speed	4 speed	5 speed	4 speed	5 speed	
Caravelle, Combi, Van, Double Cab . . . . .	103	110	115		127	127	122
High roofed Van . . . . .	103	105	110		122	122	117
Pick-up, Large platform Pick-up . . . . .	103	107	112		124	124	119

## TECHNICAL DATA

### HILL CLIMBING ABILITY

With full load on good roads driving non-stop in 1st gear.

Values in %, approx.

<b>Carburetor engines</b>	4 speed	5 speed	Automatic	syncro 4 + G
44 kW	28	30	–	–
57 kW	30	33	46	54
<b>Petrol injection engines</b>				
70 kW	–	38	50	61
82 kW	–	38	49	70
<b>Diesel engines</b>				
37 kW	26	26	–	–
42 kW	25	27	–	–
51 kW	33	32	–	58

**SPARK PLUGS**

**44 and 57 kW engines**

Genuine Part Number  
191 905 450 A / W 7 DTC

**70 kW engine**

Genuine Part Number  
N 017 812 70 / W 7 CCO

**82 kW engine**

Genuine Part Number  
191 905 450 C / W 5 DTC

191 905 450 C / W 5 DTC  
**Notes**

The spark plugs are renewed during the V.A.G Inspection Service.

If the spark plugs have to be renewed between the V.A.G Inspection Services, the following should be noted:

■ Engine, spark plugs and ignition system are matched to one another. To avoid faulty operation and even engine damage only the Genuine Volkswagen spark plugs for the engine concerned should be used. Important, among other things, are the number of electrodes and the heat value.

As the fact that the plugs may be altered at short notice for technical reasons during the current model year cannot be excluded, the plugs used can differ from those listed here. It is therefore advisable to obtain plugs only from V.A.G Dealers – they have the latest information.

**VEE BELTS**

**Petrol engines**

	Genuine Part No.	Belt size
Crankshaft/coolant pump/alternator	025903137 A	9.5 × 1100 LA <sup>1)</sup>
Crankshaft/coolant pump/alternator when cyclone filter is fitted	025903137	9.5 × 1080 LA <sup>1)</sup>
Crankshaft/air conditioner compressor	025260849 B	12.5 × 1153 LA
Crankshaft/servo steering pump	025903137	9.5 × 1080

**Diesel engines**

Crankshaft/coolant pump	068121039 B	9.5 × 643 LA <sup>1)</sup>
Coolant pump/alternator	068903137 C	9.5 × 600 LA
Crankshaft/air conditioner compressor	068260849 D	9.5 × 1250
Crankshaft/servo steering pump	068145271 C	9.5 × 763

<sup>1)</sup> The Vee belt is absolutely essential for the running of the engine. For this reason therefore, one is advised to carry a spare belt in reserve on the vehicle (see also "Operation" section, Generator warning lamp, page 34).

**Note**

The vee belts are among the most severely stressed parts of a vehicle. The belts must therefore be subject to very high quality requirements. When renewing a belt it is not sufficient to use just any belt of the same size. For safe operation only

the special Genuine Volkswagen belt for the vehicle concerned should be used. The correct belts can be obtained from V.A.G Dealers under the Genuine Part number given.

# TECHNICAL DATA

## WHEELS

Steel wheels Alloy wheels	Rear wheel drive		Four wheel drive		
	5½ J x 14	6 J x 14	5½ J x 14	6 J x 14 6 J x 14	5½ J x 16
<b>Tyres</b>	185 R 14 C	185 R 14 C	185 R 14 C	185 R 14 C	195 R 16 C
Tubeless	6 PR	6 PR	6 PR/8 PR	6 PR/8 PR	8 PR
radials	205/70 R 14	205/70 R 14	205/70 R 14	205/70 R 14	205 R 16
	97 R	97 R	97 R	97 R	104 R
	Reinforced	Reinforced	Reinforced	Reinforced	Reinforced
				205 R 14 C	6.50 R 16
				6 PR/8 PR	10 PR

**Recommended winter tyres/Wheels:** 185 R 14 C on 5½ J x 14 wheel

**If you wish to fit the vehicle with tyres or wheels of types different to those fitted by the factory (e.g. alloy wheels or wheels with winter tyres), you must pay attention to the instructions given on page 86.**

The most suitable combination is given for winter tyres for vehicles with 14 inch wheels. The remarks about winter tyres also apply to All-weather tyres. Details of whether other additional tyre/wheel combinations can be used can be obtained from V.A.G Dealers. Further details on winter tyres are given on page 89.

### Tyre pressures in bar (psi)

Rear wheel drive	Front	Rear	Spare
185 R 14 C 6 PR	2.7 (38)	3.3 (47)	3.3 (47)
Ambulance	2.5 (35)	2.5 (35)	2.5 (35)
205/70 R 14 97 R Reinforced	2.1 (30)	2.8 (40)	2.8 (40)
Four wheel drive			
185 R 14 C 6 PR/8 PR	2.8 (40)	3.5 (50)	3.5 (50)
205/70 R 14 97 R Reinforced	2.5 (35)	2.8 (40)	2.8 (40)
205 R 14 C 6 PR/8 PR	2.5 (35)	3.0 (42)	3.0 (42)
195 R 16 C 8 PR	3.0 (42)	3.5 (50)	3.5 (50)
205 R 16 Reinforced	1.8 (25)	2.1 (30)	2.1 (30)
6.50 R 16 10 PR	3.0 (42)	3.5 (50)	3.5 (50)

These pressures are for cold tyres – the pressure is higher when tyres are warm but it must not be reduced.

The type pressures must be checked regularly. Correct pressures are of great importance, particularly at high speed – see page 87.



## WEIGHTS (KG)

Normal payload	GVW		Unladen weight (with driver)		Payload <sup>2)</sup>		Permissible front axle load	Permissible rear axle load	Permissible roof load <sup>4)</sup>
	Petrol	Diesel	Petrol	Diesel	Petrol	Diesel <sup>5)</sup>			
Van	2390	2460	1395	1465	995	995	1200		
High Roofed Van	2390	2460	1445	1515	945	945	1200	1300	100
Combi	2390	2460	1395 <sup>1)</sup>	1465 <sup>1)</sup>	995 <sup>3)</sup>	995 <sup>3)</sup>	1200	1300	-
High Roofed Combi	2390	2460	1445 <sup>1)</sup>	1515 <sup>1)</sup>	945 <sup>3)</sup>	995 <sup>3)</sup>	1200	1300	100
Caravelle, Combi L	2390	2460	1480 <sup>1)</sup>	1550 <sup>1)</sup>	910 <sup>3)</sup>	910 <sup>3)</sup>	1200	1300	-
Caravelle Carat	2340	-	1730 <sup>1)</sup>	-	610 <sup>1)</sup>	-	1200	1300	100
Caravelle GL	2390	2360	1510 <sup>1)</sup>	1580 <sup>1)</sup>	880	880	1200	1300	75
"Joker" with pop-up roof	2340	2410	1640 <sup>1)</sup>	1710 <sup>1)</sup>	700	700	1200	1300	100
"Joker" with high roof	2340	2410	1700 <sup>1)</sup>	1770 <sup>1)</sup>	640	640	1200	1300	50
Ambulance	2300	2400	1680	1750	710	650	1200	1200	-
High roofed ambulance	2390	2400	1900	1950	490	430	1200	1200	100
Pick-up	2390	2460	1395	1465	995	995	1200	1300	-
Pick-up with large platform	2390	2460	1490	1560	900	900	1200	1300	-
Double Cab	2390	2460	1480	1550	910	940	1200	1300	75

### Notes

■ Other model versions and optional extras – e.g. catalytic converter, air conditioner, sliding roof, towing bracket etc. and service installation of accessories increases the unladen weight and the payload has to be reduced by this amount.

■ When carrying heavy loads, the load should, in the interests of good handling, be placed, where possible, between the axles. The permissible axle and gross vehicle weights must not be exceeded on any account. Bear in mind also that heavy weights will alter the vehicle handling. Driving style and speed must therefore be changed to suit.

■ The load must be stowed so that it cannot slide about or even fly forward when the brakes are applied.

1) Without driver

2) On vehicles with automatic gearbox the payload is reduced by about 40 kg.

3) On vehicles with 3 seats the payload is increased by about 65 kg.

4) Use only racks supported in rain channel. Load evenly and do not exceed the GVW. Further details are given on page 22.

5) On vehicles with Turbo Diesel engine the payload is reduced by 15 kg.

# TECHNICAL DATA

Higher payload	Permissible	Unladen weight (with driver)		Payload <sup>2)</sup>		Permissible	Permissible	Permissible
	GVW	Petrol	Diesel	Petrol	Diesel <sup>5)</sup>	front axle load	rear axle load	roof load <sup>4)</sup>
Van	2600	1395	1465	1205	1135	1300	1400	100
High Roofed Van	2600	1445	1515	1155	1085	1300	1400	-
Combi	2600	1395 <sup>1)</sup>	1465 <sup>1)</sup>	1205 <sup>3)</sup>	1135 <sup>3)</sup>	1300	1400	100
High Roofed Van	2600	1445 <sup>1)</sup>	1515 <sup>1)</sup>	1155 <sup>3)</sup>	1085 <sup>3)</sup>	1300	1400	-
Caravelle, Combi L	2600	1480 <sup>1)</sup>	1550 <sup>1)</sup>	1120 <sup>3)</sup>	1090 <sup>3)</sup>	1300	1400	100
Pick-up	2600	1395	1465	1205	1135	1300	1400	-
Pick-up with large platform	2600	1490	1560	1110	1040	1300	1400	-
Double Cab	2600	1450	1520	1150	1080	1300	1400	75

## Notes

■ Other model versions and optional extras – e.g. catalytic converter, air conditioner, sliding roof, towing bracket etc. and service installation of accessories increases the unladen weight and the payload has to be reduced by this amount.

■ When carrying heavy loads, the load should, in the interests of good handling, be placed, where possible, between the axles. The permissible axle and gross vehicle weights must not be exceeded on any account. Bear in mind also that heavy weights will alter the vehicle handling. Driving style and speed must therefore be changed to suit.

■ The load must be stowed so that it cannot slide about or even fly forward when the brakes are applied.

<sup>1)</sup> Without driver

<sup>2)</sup> On vehicles with automatic gearbox the payload is reduced by about 40 kg.

<sup>3)</sup> On vehicles without seats the payload is increased by about 65 kg.

<sup>4)</sup> Use only racks supported in rain channel. Load evenly and do not exceed the GVW. For further details – see page 22.

<sup>5)</sup> On vehicles with Turbo Diesel engine the payload is reduced by 15 kg.

## WEIGHTS (SYNCRO)

In kg	GWW	Unladen weight (with driver)	Payload <sup>4)</sup>	Permissible front axle load	Permissible rear axle load	Permissible roof load <sup>3)</sup>
Van	2500	1540	960	1300	1380	100
High Roofed Van	2500	1590	910	1300	1380	-
Combi	2500	1540 <sup>1)</sup>	960 <sup>2)</sup>	1300	1380	100
High Roofed Combi	2500	1590 <sup>1)</sup>	910 <sup>2)</sup>	1300	1380	-
Caravelle/Combi L	2500	1625 <sup>1)</sup>	875 <sup>2)</sup>	1300	1380	100
Caravelle GL	2500	1655 <sup>1)</sup>	845	1300	1380	100
"Joker" with pop-up roof	2500	1785 <sup>1)</sup>	715	1300	1380	50
"Joker" with high roof	2500	1845 <sup>1)</sup>	655	1300	1380	-
Ambulance	2500	1825	675	1300	1380	100
Pick-up	2500	1540	960	1300	1380	100
Pick-up with large platform	2500	1635	865	1300	1380	100
Double Cab	2500	1595	905	1300	1380	75

### Notes

■ Other model versions and optional extras – e.g. catalyst, air conditioner, sliding roof, towing bracket etc. and service installation of accessories increases the unladen weight and the payload has to be reduced by this amount.

■ When carrying heavy loads, the load should, in the interests of good handling, be placed, where possible, between the axles. The permissible axle and gross vehicle weights must not be exceeded on any account. Bear in mind also that heavy weights will alter the vehicle handling. Driving style and speed must therefore be changed to suit.

■ The load must be stowed so that it cannot slide about or even fly forward when the brakes are applied.

■ The payload must be reduced by 200 kg when travelling cross-country (does not apply to vehicles with 16 inch wheels).

<sup>1)</sup> Without driver

<sup>2)</sup> On vehicles without seats the payload is increased by about 65 kg.

<sup>3)</sup> Use only racks supported in rain channel. Load evenly and do not exceed the GWW.

<sup>4)</sup> On vehicles with Turbo Diesel engine the payload is reduced by 15 kg.

On vehicles with 16 inch wheels the payload must be reduced by 50 kg.

# TECHNICAL DATA

## TRAILER WEIGHTS

See also "Trailer towing" on page 60	44 kW		57 kW 70 kW 82 kW	Turbo Diesel	Auto- matic	Diesel engine	syncro 57, 82 kW Turbo Diesel	70 kW
	4 speed	5 speed						
<b>Permissible trailer weights</b>								
Trailer with brakes gradient up to 12% . . . . . kg	1500	1500	1500	1500	1500	1200	2000	1600
with higher payload . . kg	1300	1300	1300	1300	-	1000	-	-
Special certificate <sup>2)</sup>								
gradient up to 10% . . kg	1800	-	-	2000	-	-	2500 <sup>1)</sup>	-
with higher payload . . kg	1600	-	-	1800	-	-	-	-
gradient up to 12% . . kg	-	2000	2000	-	-	1400	-	-
with higher payload . . kg	-	1800	1800	-	-	1200	-	-
Trailer without brakes . . kg	600	600	600	600	600	600	600	600
<b>Permissible nose weight</b> of trailer drawbar on the ball of towing								
bracket max. kg	50	50	50	50	50	50	75	75
Special certificate <sup>2)</sup> max. kg	75	75	75	75	75	75	-	-
min. kg								

4% of actual trailer weight, but not more than the maximum permitted

<sup>1)</sup> Rear axle loading min. 1000 kg

<sup>2)</sup> V.A.G dealers have the details

## DIMENSIONS

in mm	Length	Width	Height		Ground clearance <sup>1)</sup>	Overhang		Wheel-base	Track		Turning circle in m
			with cover	without cover		front	rear		front	rear	
Van	4570	1845	1965	-	190	1160	950	2460	1583	1570	10.7
High Roofed Van	4570	1845	2365	-	190	1160	950	2460	1583	1570	10.7
Combi	4570	1845	1960	-	190	1160	950	2460	1583	1570	10.7
High Roofed Combi	4570	1845	2360	-	190	1160	950	2460	1583	1570	10.7
Caravelle CL, GL, Combi L	4600	1845	1950	-	190	1175	965	2460	1583	1570	10.7
Caravelle Carat	4605	1845	1960	-	190	1180	965	2460	1583	1570	10.7
"Joker" with pop-up roof	4570	1845	2075	-	190	1160	950	2460	1603	1588	10.9
"Joker" with high roof	4570	1845	2650	-	190	1160	950	2460	1583	1570	10.7
Ambulance	4570	1845	2215	-	190	1160	950	2460	1583	1570	10.7
Pick-up	4570	1870	1930	2235	190	1160	950	2460	1583	1570	10.7
Pick-up with large platform	4570	2000	1930	2235	190	1160	950	2460	1583	1570	10.7
Double Cab	4570	1870	1925	2230	190	1160	950	2460	1583	1570	10.7

<sup>1)</sup> at permissible GVW

When negotiating steep ramps, driving over poor surfaces, curbs etc., particularly with vehicles with a spoiler, gas containers and heater mounted underneath the floor, care must be taken not to "bottom" and thus cause damage to these fittings.

On vehicles with low-set running gear the ground clearance is reduced by about 30 mm.

## TECHNICAL DATA

### DIMENSIONS (syncro with 14 inch wheels)

in mm	Lenght	Width	Height		Ground clearance <sup>1)</sup>		Overhang		Wheel base	Track		Turning circle in m	Wading Depth <sup>2)</sup>
			without cover	with cover	front	rear	front	rear		front	rear		
Van	4570	1845	1990	–	215	193	1160	950	2455	1568	1560	10.9	350
High Roofed Van	4570	1845	2390	–	215	193	1160	950	2455	1568	1560	10.9	350
Combi	4570	1845	1990	–	215	193	1160	950	2455	1568	1560	10.9	350
High Roofed Combi	4570	1845	2390	–	215	193	1160	950	2455	1568	1560	10.9	350
Caravelle CL, GL, Combi L	4600	1845	1990	–	215	193	1175	950	2455	1568	1560	10.9	350
“Joker” with pop-up roof	4570	1845	2105	–	215	193	1160	950	2455	1568	1560	10.9	350
“Joker” with high roof	4570	1845	2680	–	215	193	1160	950	2455	1568	1560	10.9	350
Ambulance	4570	1845	2245	–	215	193	1160	950	2455	1568	1560	10.9	350
Pick-up	4570	1870	1995	2265	215	193	1160	950	2455	1568	1560	10.9	350
Pick-up with large platform	4570	2000	1995	2265	215	193	1160	950	2455	1568	1560	10.9	350
Double Cab	4570	1870	1995	2265	215	193	1160	950	2455	1568	1560	10.9	350

<sup>1)</sup> at permissible GVW with 185 R 14 C tyres, with 205 R 14 tyres ground clearance is increased by 14 mm.

When negotiating steep ramps, driving over poor surfaces, curbs etc., particularly with vehicles with a spoiler, gas containers and heater mounted underneath the floor, care must be taken not to “bottom” and thus cause damage to these fittings.

<sup>2)</sup> The wading depth for vehicles with turbocharged Diesel engine is 200 mm.

## DIMENSIONS (syncro with 16 inch wheels)

in mm	Lenght	Width	Height <sup>1)</sup>		Ground clearance <sup>1)</sup>		Overhang		Wheel base	Track		Turning circle in m	Wading Depth
			without cover	with cover	front	rear	front	rear		front	rear		
Van	4570	1845	2020	–	246	218	1160	925	2480	1597	1590	11.3	390
High Roofed Van	4570	1845	2420	–	246	218	1160	925	2480	1597	1590	11.3	390
Combi	4570	1845	2020	–	246	218	1160	925	2480	1597	1590	11.3	390
High Roofed Combi	4570	1845	2420	–	246	218	1160	925	2480	1597	1590	11.3	390
Caravelle CL, GL, Combi L	4600	1845	2020	–	246	218	1175	925	2480	1597	1590	11.3	390
"Joker" with pop-up roof	4570	1845	2135	–	246	218	1160	925	2480	1597	1590	11.3	390
"Joker" with high roof	4570	1845	2710	–	246	218	1160	925	2480	1597	1590	11.3	390
Ambulance	4570	1845	2275	–	246	218	1160	925	2480	1597	1590	11.3	390
Pick-up	4570	1870	2025	2295	246	218	1160	925	2480	1597	1590	11.3	390
Pick-up with large platform	4570	2000	2025	2295	246	218	1160	925	2480	1597	1590	11.3	390
Double Cab	4570	1870	2025	2295	246	218	1160	925	2480	1597	1590	11.3	390

<sup>1)</sup> at permissible GVW with 195 R 16 tyres. With 205 R 16 tyres the figure is increased by 8 mm.  
 When negotiating steep ramps, driving over poor surfaces, curbs etc., particularly with vehicles with a spoiler, gas containers and heater mounted underneath the floor, care must be taken not to "bottom" and thus cause damage to these fittings.

## TECHNICAL DATA

### CAPACITIES

---

Fuel tank .. approx. 60 litres (13 galls)  
Fuel tank  
syncro ... approx. 70 litres (15.3 galls)  
Windscreen washer .. approx. 3.5 litres  
With headlight  
washer ..... approx. 6.5 litres  
Rear window  
washer ..... approx. 1.0 litre

#### **Petrol engines**

Cooling system  
(with heater) ..... approx. 17.5 litres  
Engine oil -  
with filter change ... approx. 4.5 litres  
Engine oil -  
without filter change approx. 4.0 litres  
Difference between  
Max.-Min. marks on dipstick .. 1.0 litre

#### **Diesel engines**

Cooling system  
(with heater) ..... approx. 16 litres  
Engine oil -  
with filter change .... approx. 4.5 litres  
Engine oil -  
without filter change . approx. 4.0 litres  
Difference between  
Max.-Min. marks  
on dipstick ..... approx. 1.0 litre



VEHICLE IDENTIFICATION DATA



**The identification plate**

is on right hand door pillar between the hinges.

Vehicles for export to certain countries have no identification plate.

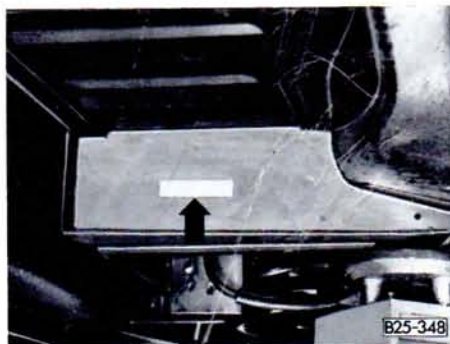

**Vehicle Identification number (Chassis number)**

is stamped under vehicle on front cross member.

1	SORT. NR.	<input type="text"/>
2	FAHRZG.-IDENT. NR. VEHICLE-IDENT. NO.	<input type="text"/>
3	TYP./TYPE	<input type="text"/>
4		<input type="text"/>
5	MOTORKB. / GETR. KB. ENG. CODE / TRANS. CODE	<input type="text"/> <input type="text"/>
6	LACKNR. / INNENAUSST. PAINT NO. / INTERIOR	<input type="text"/> <input type="text"/> <input type="text"/>
7	M - AUSST. / OPTIONS	<input type="text"/>

B 17- 183

**The vehicle data sticker**

is located on cross member on left under dash. The sticker contains the following data:

1. Production control number
2. Vehicle identification number
3. Model code number
4. Model explanation
5. Engine and gearbox code letters
6. Paint number/interior trim code
7. Optional extra number

The vehicle data 2-7 is also given in the Service Schedule.



### Engine number

On the petrol engines the number is stamped on the block behind the vee belt pulley. It can be seen when maintenance flap is opened.

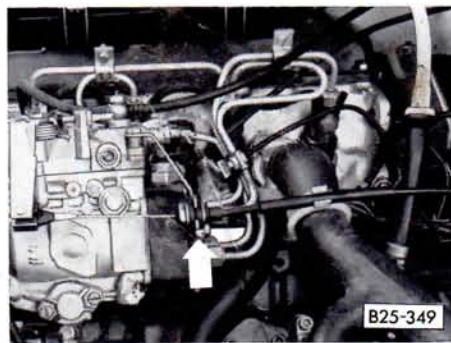

On the Diesel engine the number is stamped in the block near the injection pump.

# ALPHABETICAL INDEX

	Page		Page		Page
Additional heat exchanger . . . . .	46	Catalytic converter . . . . .	90, 117	Cubic capacity . . . . .	119
Adjusting jets . . . . .	80	Cavity preservation . . . . .	93	Curtains . . . . .	55
Alloy wheels . . . . .	95	Centre seat . . . . .	17		
Anti-freeze . . . . .	77	Central locking . . . . .	8		
Anti-knock petrol . . . . .	68	Cetane number . . . . .	69	<b>Defrosting windows . . . . .</b>	<b>45</b>
Anti-locking system (ABS) . . . . .	36, 83	Changing bulbs . . . . .	104	Diesel fuel . . . . .	69
Ashtray . . . . .	54	Changing wheels . . . . .	101	Differential locks . . . . .	25
ATF . . . . .	73, 75	Changing wiper blades . . . . .	109	Difficult conditions . . . . .	91
Automatic gearbox . . . . .	28	Chassis number . . . . .	135	Digital clock . . . . .	37
Automatic seat belts . . . . .	13	Childs seat . . . . .	13	Dimensions . . . . .	131
Auxiliary heater . . . . .	47, 50	Child-proof lock . . . . .	9	Dipstick . . . . .	
		Cigarette lighter . . . . .	54	– engine . . . . .	74
<b>Battery acid level . . . . .</b>	<b>84</b>	Cleaning and preserving engine . . . . .		– automatic gearbox . . . . .	75
Battery/acid . . . . .	84	compartment . . . . .	96	Dip switch . . . . .	41
Brake fluid . . . . .	82	Clock . . . . .	37	Do-it-yourself . . . . .	99
Brake servo . . . . .	81	Cold starting aid . . . . .	4, 32	Doors . . . . .	9
Brake system . . . . .	81	Compression ratio . . . . .	119	Drawbar weight . . . . .	130
Brake warning light . . . . .	36	Consumption figures . . . . .	120	Drivers seat . . . . .	16
Bulb changing . . . . .	104	Coolant additive . . . . .	77	Driving abroad . . . . .	91
		Coolant level . . . . .	78	Driving economically . . . . .	58
<b>Care of body . . . . .</b>	<b>96</b>	Coolant temperature gauge . . . . .	38	Driving environment – conscious . . . . .	58
Care of car . . . . .	92	Cooling system . . . . .	77	Driving safely . . . . .	57
Canopy . . . . .	23	Cover, engine . . . . .	10	Driving tips . . . . .	57
Capacities . . . . .	134	Cruise control system . . . . .	42	Dropsides . . . . .	23

# ALPHABETICAL INDEX

	Page		Page		Page
Electric window lifters . . . . .	11	- gauge . . . . .	38	<b>Jack</b> . . . . .	99
Electric seat adjustment . . . . .	20	- saving . . . . .	58	Jacking points . . . . .	101
Emergency light system . . . . .	39	Fuses . . . . .	102	Jets adjusting . . . . .	80
Emergency starting . . . . .	111	<b>Gear lever</b> . . . . .	24	<b>Kick-down</b> . . . . .	28
Emission control system . . . . .	90, 117	Gear oil . . . . .	75	Keys . . . . .	7
Engine		Glove box . . . . .	55	<b>Lambda probe</b> . . . . .	118
- data . . . . .	119	Glow plugs . . . . .	32, 35	Lamps, warning . . . . .	6
- number . . . . .	136	<b>Handbrake</b> . . . . .	23	Lap belts . . . . .	15
- oil . . . . .	72	Headlights . . . . .	39, 104	Leadfree petrol . . . . .	68
- oil capacity . . . . .	134	- masking . . . . .	109	Lifting vehicle . . . . .	98
- oil consumption . . . . .	59	Headlight flasher . . . . .	41	Lighting . . . . .	39
- oil level . . . . .	74	Head restraints . . . . .	15	Lighting, number plate . . . . .	107
- starting/stopping . . . . .	31	Heating . . . . .	44	Lighting switch . . . . .	39
Engine compartment flap . . . . .	10	High beam . . . . .	35, 41	Load surface . . . . .	22
<b>Filling tank</b> . . . . .	70	Horn . . . . .	4	Load surface, increasing size of . . . . .	22
First Aid Kit . . . . .	99	<b>Identification plate</b> . . . . .	135	Locks . . . . .	9
Floor mats . . . . .	83	Ignition switch . . . . .	30	Locks door . . . . .	9
Fog lights . . . . .	40	Instrument lighting . . . . .	39	Lubricants . . . . .	72
Four wheel drive . . . . .	63	Instrument panel . . . . .	4	Luggage compartment . . . . .	22
Frozen locks . . . . .	93	Instruments . . . . .	37	Luggage compartment cover . . . . .	22
Fuel . . . . .	68	Interior light . . . . .	53	<b>Maintenance</b> . . . . .	97
- additives . . . . .	72				
- consumption . . . . .	121				

# ALPHABETICAL INDEX

	Page		Page
Maximum engine speed . . . . .	56	Pedals . . . . .	83
Maximum road speed . . . . .	123	Petrol . . . . .	68
Make-up mirror . . . . .	54	Petrol consumption . . . . .	121
Mileage recorder . . . . .	37	Petrol additives . . . . .	69
Mirrors . . . . .	12	Performance . . . . .	123
M + S tyres . . . . .	89	Power assisted steering . . . . .	76
Number plate lighting . . . . .	107	Radiator fan . . . . .	79
 		Radio . . . . .	5, 110
Octane number . . . . .	68	Rear fog light . . . . .	40
Oil additives . . . . .	72	Rear lights . . . . .	106
Oil change intervals . . . . .	73	Rear seat . . . . .	17
Oil consumption . . . . .	59, 119	Rear view mirror . . . . .	12
Oil dipstick . . . . .	74	Rear window heated . . . . .	39
Oils . . . . .	73	Rear wiper and washer . . . . .	43
Oil specifications . . . . .	72, 73	Reclining seat . . . . .	21
Outside mirrors . . . . .	12	Rev counter . . . . .	37
Output . . . . .	119	Reverse gear . . . . .	24
 		Reversing lights . . . . .	24
Paint number . . . . .	135	Revolving seats . . . . .	17
Paint care . . . . .	93	Roof load . . . . .	129
Payload . . . . .	127	Roof rack . . . . .	22
Parking lights . . . . .	41	Running in . . . . .	56
Power transmission . . . . .	125		
		Safety switch . . . . .	49
		Seat adjustment . . . . .	16
		Seat belts . . . . .	13
		Seats . . . . .	16
		Seat heating . . . . .	16, 40
		Selector lever . . . . .	24
		Side lights . . . . .	39
		Sliding door . . . . .	9
		Sliding roof . . . . .	52
		Sliding windows . . . . .	11
		Snow chains . . . . .	89
		Socket . . . . .	54
		Spare wheel . . . . .	100
		Spark plugs . . . . .	125
		Speedometer . . . . .	37
		Starting engine . . . . .	31
		Starting aid cable . . . . .	111
		Steering lock/ignition switch . . . . .	31
		Steel sliding roof . . . . .	52
		Stopping engine . . . . .	31
		Sun roof . . . . .	52
		Sun visors . . . . .	54
		Switches . . . . .	39

# ALPHABETICAL INDEX

	Page		Page		Page
Syncro		Turn signals . . . . .	41, 106	Water auxiliary heater . . . . .	47, 50
- towing . . . . .	112	Turn signal lever . . . . .	41	Weights . . . . .	127
- differential locks . . . . .	25	Tyres		Wheels . . . . .	85, 127
- driving with 4 wheel drive . . . . .	63	- inflation pressures . . . . .	126	Wheel changing . . . . .	101
- snow chains . . . . .	89	- running in . . . . .	85	Windows . . . . .	11
- technical description . . . . .	114	- wear . . . . .	87	Window deicing . . . . .	94
- technical data . . . . .	119	- condition . . . . .	87	- defrosting . . . . .	45
<b>Table</b> . . . . .	55	<b>Unbalanced wheels</b> . . . . .	88	Windscreen washer system . . . . .	43, 80
Tailgate . . . . .	10	Undercoating . . . . .	96	Windscreen wipers . . . . .	43
Taillights . . . . .	106	Unleaded petrol . . . . .	68	Winter driving . . . . .	85, 92
Tank cap . . . . .	70	<b>Vee belts</b> . . . . .	125	Wiper blades . . . . .	109
Tank capacity . . . . .	134	Vehicle care . . . . .	90	Wipe/wash system . . . . .	43
Technical data . . . . .	119	Vehicle data sticker . . . . .	135	Winter tyres . . . . .	123
Technical description . . . . .	113	Vehicle identification data . . . . .	135		
Tools . . . . .	99	Ventilation . . . . .	44, 45		
Towing . . . . .	112	Vent wings . . . . .	11		
Tow starting . . . . .	29, 90	Viscosity grades . . . . .	72, 73		
Trailer towing . . . . .	60	Viscous coupling . . . . .	63		
Trailer weights . . . . .	130	<b>Warning lamps</b> . . . . .	34		
Travelling abroad . . . . .	91	Warning triangle . . . . .	99		
Tread depth . . . . .	87	Washerjets adjusting . . . . .	80		
Trip recorder . . . . .	37				
Trolley jack . . . . .	98				

The factory is working continuously on the development of all models. We trust, therefore, that you will appreciate that we must reserve the right to alter, without notice, any part of the vehicle or equipment. No legal commitment is thus implied by the data, illustrations or descriptions in this manual.

© 1987 VOLKSWAGEN AG

May not be reproduced or translated in whole or in part without the written consent of Volkswagen AG. All rights reserved. Specifications subject to alteration without notice.

Printed in Germany

englisch 7.87

881.551.250.20